

Features

Unregulated Converters

- Fully RoHS 6/6 Conform
- Full Power at 100°C Ambient Temperature
- 1kVDC or 3kVDC Isolation Options
- Suitable for Fully Automated Assembly (including Vapour Phase Soldering)
- Optional Continuous Short Circuit Protection

Selection Guide

Part Number SMD	(3kV)	Input Voltage (VDC)	Output Voltage (VDC)	Output Current (mA)	Capacitive Load (max.)
R0.25S**-xx3.3	(H)	3.3, 5, 12, 15, 24	3.3	76	1000µF
R0.25S**-xx05	(H)	3.3, 5, 12, 15, 24	5	50	470µF
R0.25S**-xx09	(H)	3.3, 5, 12, 15, 24	9	28	470µF
R0.25S**-xx12	(H)	3.3, 5, 12, 15, 24	12	21	150µF
R0.25S**-xx15	(H)	3.3, 5, 12, 15, 24	15	17	68µF
R0.25S**-xx24	(H)	3.3, 5, 12, 15, 24	24	10.4	68µF
R0.25D**-xx3.3	(H)	3.3, 5, 12, 15, 24	±3.3	±38	470µF
R0.25D**-xx05	(H)	3.3, 5, 12, 15, 24	±5	±25	220µF
R0.25D**-xx09	(H)	3.3, 5, 12, 15, 24	±9	±14	68µF
R0.25D**-xx12	(H)	3.3, 5, 12, 15, 24	±12	±10.4	68µF
R0.25D**-xx15	(H)	3.3, 5, 12, 15, 24	±15	±8.3	68µF
R0.25D**-xx24	(H)	3.3, 5, 12, 15, 24	±24	±5.2	33µF
R0.25DA**-xx0505		3.3, 5, 12, 15, 24	5/5	25/25	220µF/220µF
R0.25DA**-xx1212		3.3, 5, 12, 15, 24	12/12	10/10	68µF/68µF

xx = Input Voltage (other input and output voltage combinations available on request)

* add Suffix "H" for 3kV Isolation, e.g. R0.25S-0505/H, R0.25D-0505/H, R0.25S12-0505/H, R0.25D12-0505/H

* add Suffix "P" for Continuous Short Circuit Protection, e.g. R0.25S8-0505/P, R0.25S-0505/HP, R0.25D12-0505/HP

* add suffix -R for tape & reel packing e.g. R0.25S-0505-R. For more details see Application Notes.

Case and Pinning Options (note restrictions on /H option)

- R0.25S** : ** without marking denotes 5 pins out of 8 fitted (includes /H option)
 ** with marking **8** denotes 8 pins out of 8 fitted (/H option not available)
 ** with marking **12** denotes 10 pins out of 12 fitted (includes /H option)
- R0.25D** : ** without marking denotes 6 pins out of 10 fitted (includes /H option, no DA option)
- R0.25D(A): ** with marking **10** denotes with 10 pins out of 10 fitted (/H option not available)
- R0.25D(A): ** with marking **12** denotes 10 pins out of 12 fitted (includes /H option - except R0.25DA)

Specifications (measured at T_A = 25°C, nominal input voltage, full load and after warm-up)

Input Voltage Range	±10%	
Output Voltage Accuracy	±5% typ., ±7% max.	
Line Voltage Regulation	(low line to high line at max. load)	2% max.
Load Voltage Regulation (10% to 100% full load)	3.3V output types	15% typ., 20% max.
	5V, 5/5V output types	12% typ., 15% max.
	9V output type	7% typ., 10% max.
	12V, 12/12V, 15V, 24V output types	6% typ., 10% max.
Output Ripple and Noise (20MHz BW limited)	100mVp-p max.	
Operating Frequency	20kHz min. / 50kHz typ. / 90kHz max.	
Efficiency at Full Load	60%-70%	
Minimum Load = 0%	Specifications valid for 10% minimum load only	
Isolation Voltage	(tested for 1 second)	1000VDC
	(rated for 1 minute)	500VAC / 60Hz
	H-Suffix (tested for 1 second)	3000VDC
R0.25DA Output/ Output Isolation Voltage	(rated for 1 minute)	1500VAC / 60Hz
	(tested for 1 second)	1000VDC
Isolation Capacitance	75pF max.	

ECONOLINE

DC/DC-Converter

RECOM

0.25 Watt SMD Single, Dual & Independent Outputs



E-224736

UL-60950-1 Certified
EN-60950-1 Certified
EN-60601-1 Certified
 (/H suffix)

R0.25S R0.25D(A)

Description

The R0.25S and R0.25D converters are of the enclosed open frame type, i.e. they are not potted.

The converters are typically used in general purpose and industrial low power isolation and voltage matching applications where an SMD converter is required.

The converter series feature an extended ambient temperature operating range of -40°C ~ +100°C without derating and optional continuous short circuit protection.

In addition to single, dual and independent outputs, two isolation options and three different case formats, the converters are also available prepacked as tape and reel for use with automatic insertion machines.

Refer to Application Notes

www.recom-electronic.com

Specifications - continued

Isolation Resistance	$V_{iso}=500V$	10 GΩ min.
Short Circuit Protection		1 Second
P-Suffix		Continuous
Operating Temperature Range (free air convection)		-40°C to +100°C (see Graph)
Storage Temperature Range		-50°C to +125°C
Reflow Temperature	ROHS compliant	245°C (30 sec), Peak 255°C (5 sec) max.
Vapour Phase Process	(for more details see Application Notes)	230°C (90 sec) max.
Relative Humidity		95% RH
Humidity Susceptibility Test		1000 hrs / 90% humidity / +85°C ambient
Package weight		1.0g (RO.25S), 1.2g (RO.25D(A))
Packing Quantity	RO.25S, RO.25S8	40 pcs per Tube
	RO.25S12, RO.25D, RO.25D10	33 pcs per tube
	RO.25D12, RO.25DA	33 pcs per tube
	All Types	500 pcs per Reel

MTBF (+25°C) (+85°C)	} Detailed Information see Application Notes chapter "MTBF"	using MIL-HDBK 217F	4423 x 10 ³ hours
		using MIL-HDBK 217F	2161 x 10 ³ hours

Certifications

CB Test Report	Report: US/14402A/UL	IEC 60950-1:2001 1st Ed.
UL General Safety	Report: E3224736	UL 60950-1 1st Ed.
CUL General Safety		C22.2 No. 60950-1-03
EN Medical Safety	Report: SPC1005061	EN60601-1
EN General Safety	Report: SPLCVD1005061	EN60950-1, 2nd Edition

Notes

Note 1: Maximum capacitive load is defined as the capacitive load that will allow start up in under 1 second without damage to the converter.

Derating-Graph (Ambient Temperature)

RO.255-0505, RO.25D-0505, RO.25DA-050505

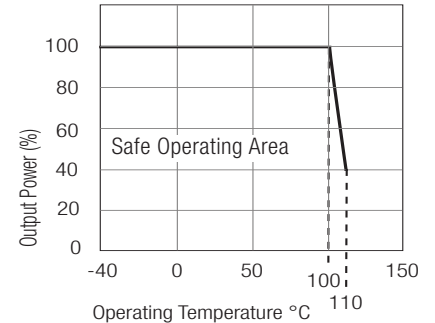

RO.25S12-0505, RO.25D12-0505, RO.25DA12-050505

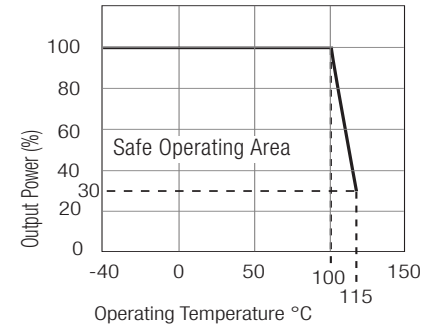

The derating graphs are valid only for the part numbers shown.

Typical Characteristics

Tolerance Envelope

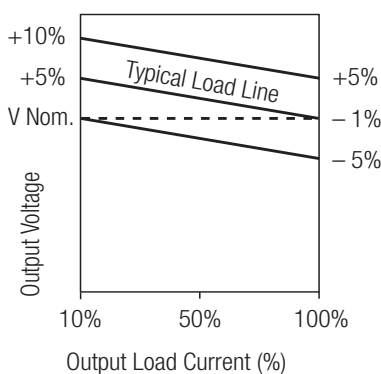

RO.25S**-xx05

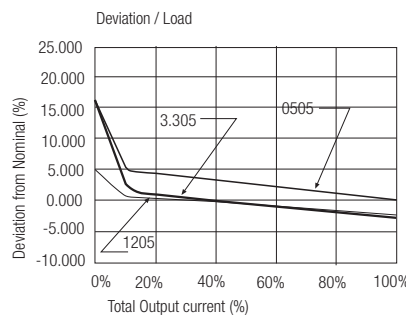
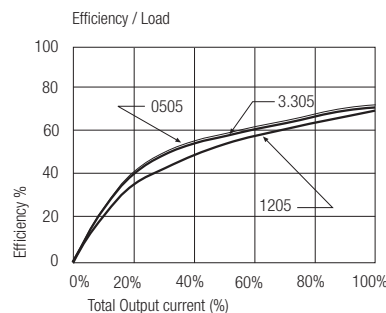

RO.25D**-xx05

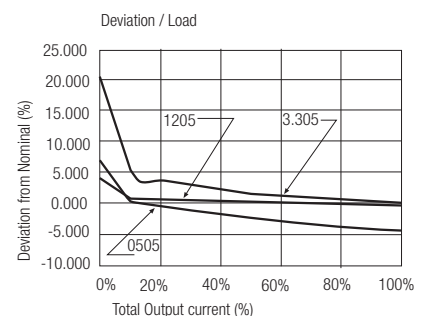
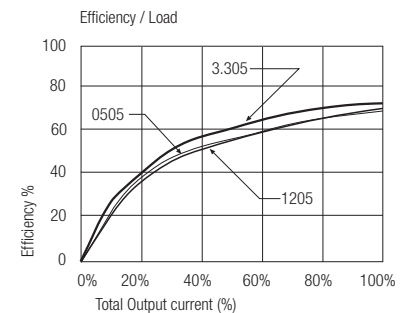

Package Style and Pinning (mm)

5 PIN Single SMD Package

Note: /H option is available in these pin packages

6 PIN Dual SMD Package

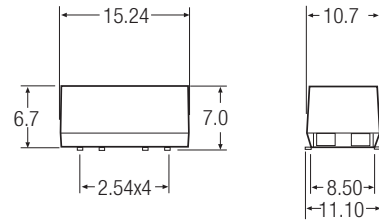
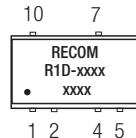
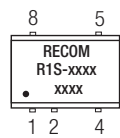
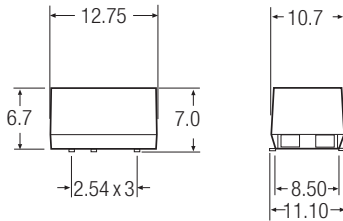

Recommended Footprint Details

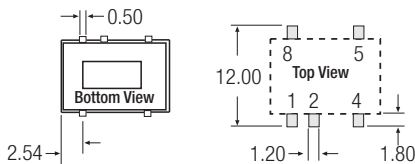

Pin Connections

Pin #	Single	Dual
1	-Vin	-Vin
2	+Vin	+Vin
4	-Vout	Com
5	+Vout	-Vout
7	No Pin	+Vout
8	NC	No Pin
10	No Pin	NC

NC = No Connection
 XX.X ± 0.5 mm
 XX.XX ± 0.25 mm

Recommended Footprint Details

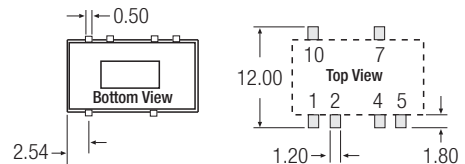

8 PIN Single SMD Package

Note: /H option is not available in these pin packages

10 PIN Dual SMD Package

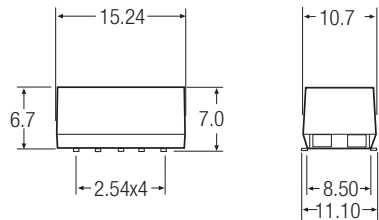
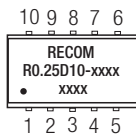
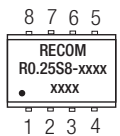
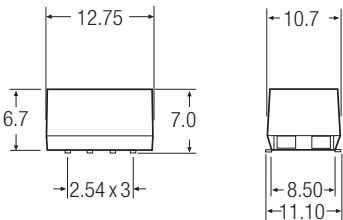

Recommended Footprint Details

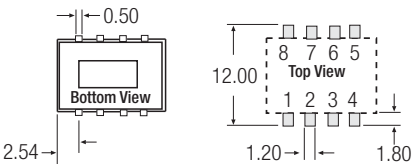

Pin Connections

Pin #	Single	Dual	Dual Independent
1	-Vin	-Vin	-Vin
2	+Vin	+Vin	+Vin
3	NC	NC	No Pin
4	-Vout	Com	-Vout1
5	+Vout	-Vout	+Vout1
6	NC	NC	-Vout2
7	NC	+Vout	+Vout2
8	NC	NC	No Pin
9	-	NC	No Pin
10	-	NC	NC

NC = No Connection
 XX.X ± 0.5 mm
 XX.XX ± 0.25 mm

Recommended Footprint Details (Dual)

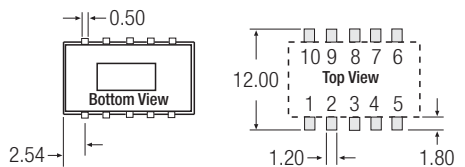

Recommended Footprint Details Dual Independent

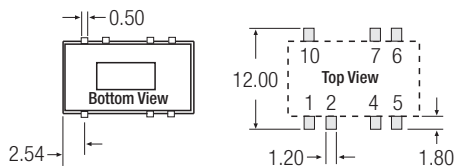

RO.25S** : ** without marking denotes 5 pins out of 8 fitted (includes /H option)
 ** with marking **8** denotes 8 pins out of 8 fitted (/H option not available)

e.g. RO.25S-0505, RO.25S-0505/H, RO.25S-0505/HP
 e.g. RO.25S8-0505, RO.25S8-0505/P

RO.25D** : ** without marking denotes 6 pins out of 10 fitted (includes /H option)
 ** with marking **10** denotes with 10 pins out of 10 fitted (/H option not available)

e.g. RO.25D-0505, RO.25D-0505/H, RO.25D-0505/HP
 e.g. RO.25D10-0505, RO.25D10-0505/P

Package Style and Pinning (mm)

12 PIN Single and Dual SMD Package

Note: /H option is available in this pin package

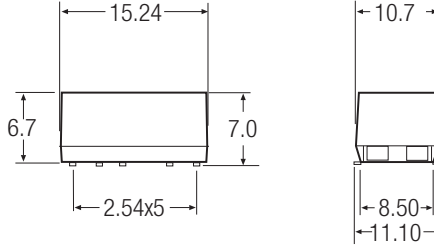
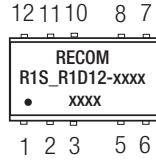

Pin Connections

Pin #	Single	Dual
1	-Vin	-Vin
2	+Vin	+Vin
3	NC	NC
5	-Vout	Com
6	NC	-Vout
7	NC	NC
8	+Vout	+Vout
10	NC	NC
11	NC	NC
12	NC	NC

NC = No Connection

XX.X ± 0.5 mm
XX.XX ± 0.25 mm

RO.25S** : ** with marking **12** denotes 10 pins out of 12 fitted (includes /H option)
e.g. RO.25S12-0505
RO.25S12-0505/H
RO.25S12-0505/HP

RO.25D** : ** with marking **12** denotes 10 pins out of 12 fitted (includes /H option)
e.g. RO.25D12-0505
RO.25D12-0505/H
RO.25D12-0505/HP

Recommended Footprint Details

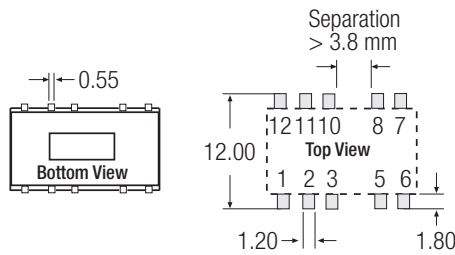

EMC Filtering - Suggestion for EN55022 Class B (Conducted and Emitted)

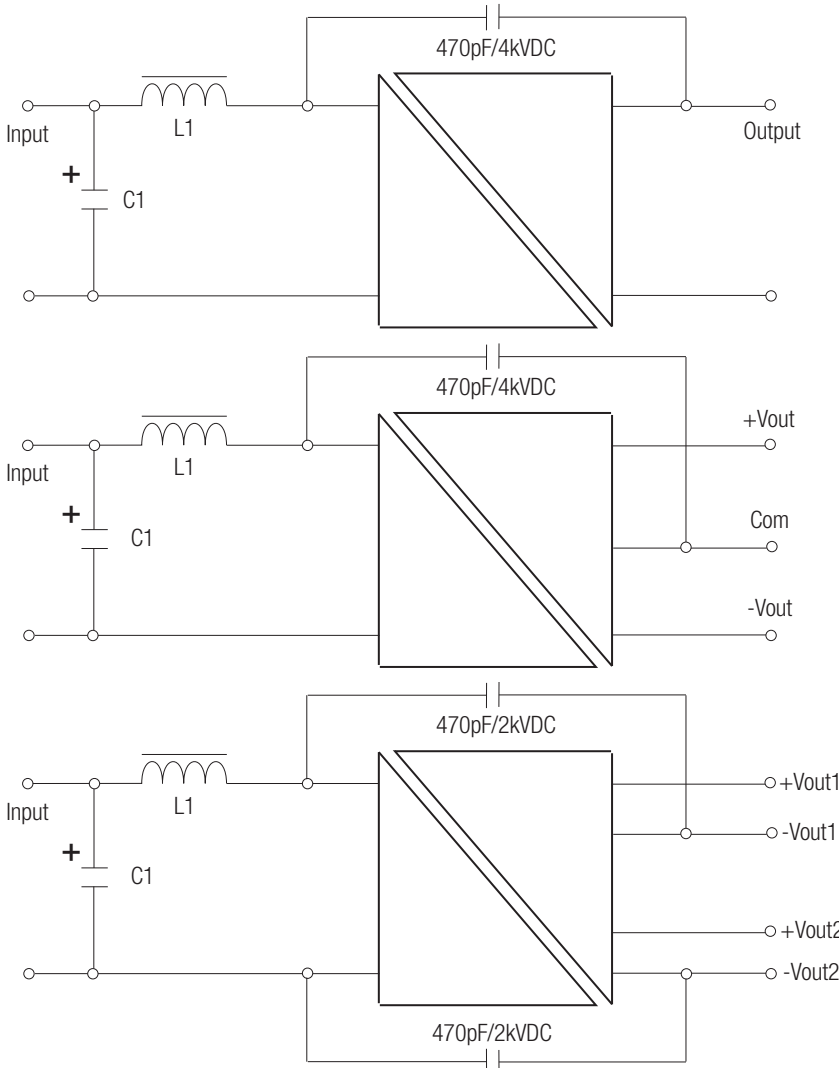

Standard and /H versions

C1	L1	Vin
2.2µF	3.3µH	3.3V
2.2µF	4.7µH	5V
2.2µF	10µH	9V
1.0µF	22µH	12V
1.0µF	22µH	15V
470nF	47µH	24V

/P and /HP versions

C1	L1	Vin
2.2µF	3.3µH	3.3V
2.2µF	4.7µH	5V
2.2µF	10µH	9V
1.0µF	22µH	12V
1.0µF	22µH	15V
470nF	47µH	24V

C1 = MLCC
L1 = SMD Inductor