

Features

- Efficiency up to 94%, no need for heatsinks!
- Pin-out compatible with LM78XX Linear Regs.
- Low profile (L*W*H=11.5*7.5*10.2mm)
- Wide input range (4.75V ~ 18V)
- Short circuit protection, thermal shutdown
- Non standard outputs available as specials
- Low ripple and noise

Selection Guide

Part Number	Input Range (V)	Output Voltage (V)	Output Current (A)	Efficiency	
				Min. Vin (%)	Max. Vin (%)
R-781.8-1.0	4.75 – 18	1.8	1.0	82	76
R-782.5-1.0	4.75 – 18	2.5	1.0	87	81
R-783.3-1.0	4.75 – 18	3.3	1.0	90	84
R-785.0-1.0	6.5 – 18	5.0	1.0	94	89

Specifications (typical at 25°C, 10% minimum load, unless otherwise specified)

Characteristics	Conditions	Min.	Typ.	Max.
Input Voltage Range	All Series	4.75V		18V
Output Voltage Range	All Series	1.5V		5.5V
Output Current	All Series	0mA*		1000mA
Output Current Limit	All Series			3000mA
Short Circuit Input Current (Vin =12V)	All Series			100mA
Internal Power Dissipation				0.4W
Short Circuit Protection		Continuous, automatic recovery		
Output Voltage Accuracy (At 100% Load)	All Series		±2%	±3%
Line Regulation (100% Load, Vin max.)	All Series		0.2%	0.4%
Load Regulation (10 to 100% full load)	All Series		0.4%	0.6%
Dynamic Load Stability	100% <-> 50% load		±85mV	±100mV
Ripple & Noise (20Mhz BW)	All Series		20mVp-p	30mVp-p
Temperature Coefficient	-40°C ~ +85°C ambient			0.015%/°C
Max capacitance Load	with normal start-up time, no external components			470µF
	with <1 second start up time + diode protection circuit			6800µF
Switching Frequency		280kHz	350kHz	430kHz
Quiescent Current	Vin = min. to max. at 0% load		5mA	7mA
Operating Temperature Range		-40°C		+85°C
Operating Case Temperature (with derating)				+100°C
Storage Temperature Range		-55°C		+125°C
Case Thermal Impedance				70°C/W
Thermal Shutdown	Internal IC junction			+160°C
Conducted Emissions (with filter)	EN55022			Class B
Radiated Emissions (with filter)	EN55022			Class B
ESD	EN61000-4-2			Class A
Radiated Immunity	EN61000-4-3			Class A
Fast Transient	EN61000-4-4			Class A
Conducted Immunity	EN61000-4-6			Class A
Magnetic Field Immunity	EN61000-4-8			Class A
Certifications				
General Safety	Report: PS080803950		EN 60950-1:2001 + All:2004	
Medical EMC	Report: 5A111502E		EN 60950-1-1-2:2002	
EMC	Report: 5A111502E		EN 55022, EN55024, EN61000	
Package Weight			1.9g	
Packing Quantity			42 pcs per Tube	
MTBF (+25°C)	} Detailed Information see Application Notes chapter "MTBF"	using MIL-HDBK 217F	13338 x 10 ³ hours.	
(+71°C)		using MIL-HDBK 217F	3880 x 10 ³ hours.	

R-78-1.0

INNOLINE
DC/DC-Converter
with 3 year Warranty

RECOM

1.0 AMP
SIP3
Single Output



EN-55022 Certified
EN-55024 Certified
EN-60601-1-2 Certified
EN-60950-1 Certified

R-78-1.0

Description

The R-78xx-1.0 series switching regulators are ideally suited to replace 1 Amp 78xx linear regulators and are pin compatible. Efficiencies of up to 97% means that very little energy is wasted as heat so there is no need for any heat sinks with their additional space and mounting costs.

Derating-Graph (Ambient Temperature)

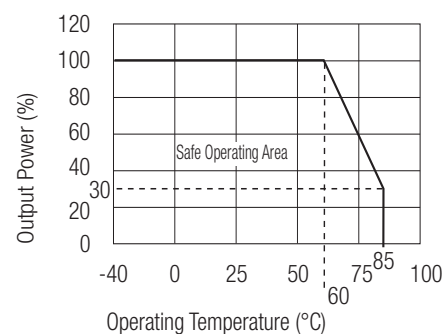

Characteristics

Efficiency

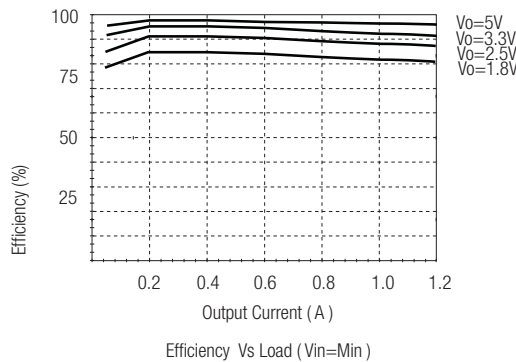
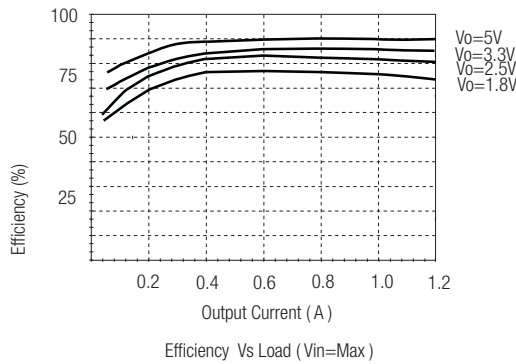
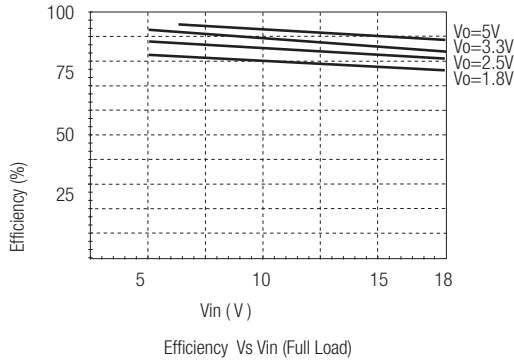

Ripple

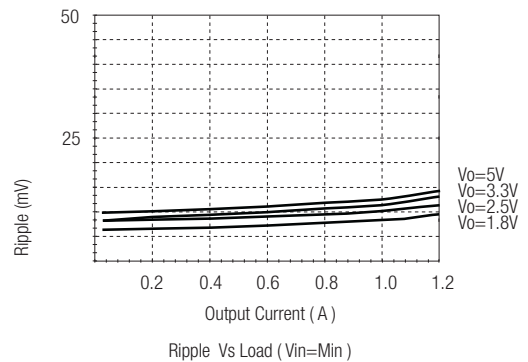
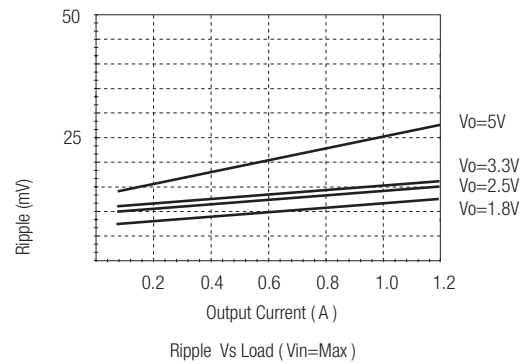
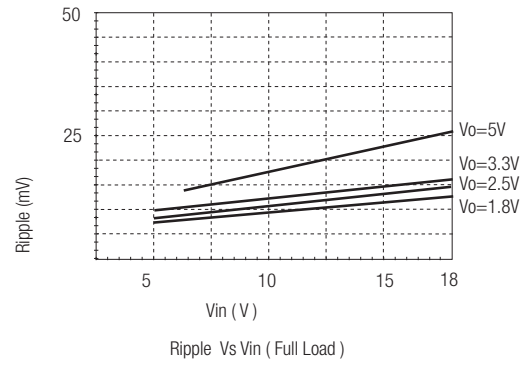

*Note: Operation under no load will not damage these devices, however they may not meet all specifications. A minimum load of 10mA is recommended

Optional Protection Circuit

Optional Protection 1:

Add a blocking diode to Vout if current can flow backwards into the output, as this can damage the converter when it is powered down.

The diode can either be fitted across the device if the source is low impedance or fitted in series with the output (recommended).

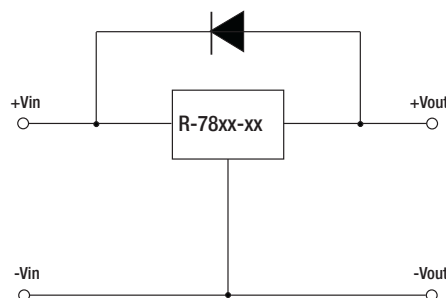

Optional Protection 2:

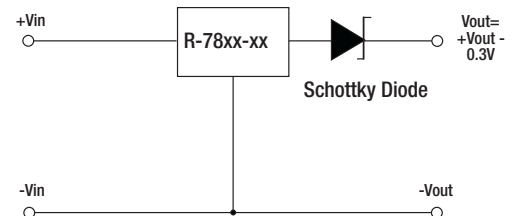

Application Examples

High efficiency, isolated, dual regulated outputs

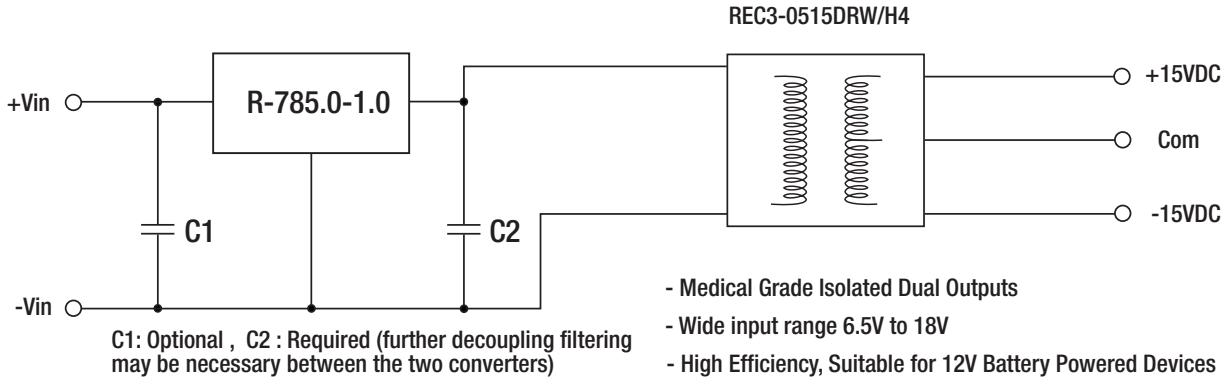

Isolated (up to 6KV), wide Input range regulated output

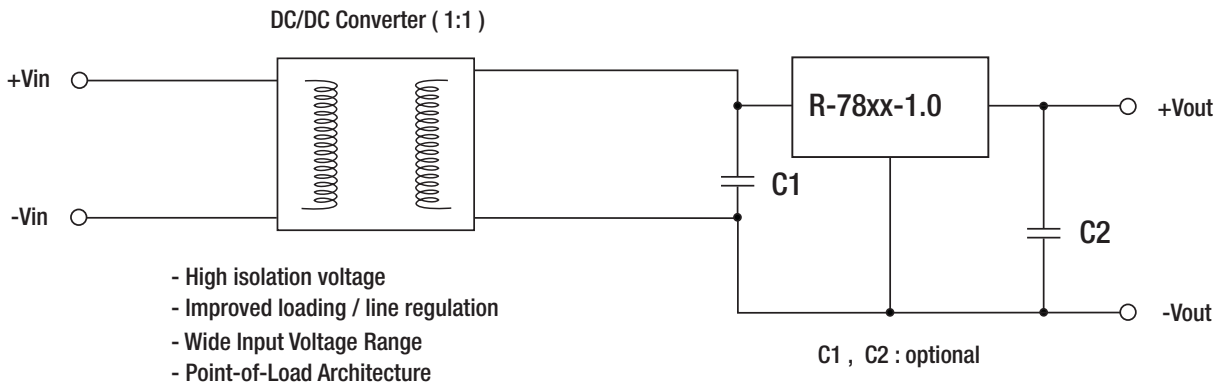

Package Style and Pinning (mm)

SIP3 PIN Package

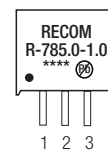
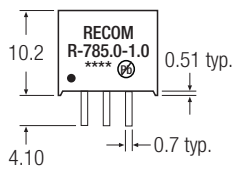

Recommended Footprint Details

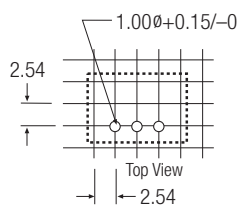

Pin Connections

Pin #	Connection
1	+Vin
2	GND
3	+Vout

xx.x \pm 0.5mm
xx.xx \pm 0.25mm