

EMI/EMC FILTER

IR2 SERIES



FEATURES

- Inlet filter with fuse holder and comply with IEC 60127-6.
- Suitable for the product that must conform to FCC,FTZ.
- Good shield effect by using metal case.
- Meet over voltage category II of IEC 60664 and comply with IEC 60950.
- Uses IEC connector that meets the safety standards of all certifying organizations.

APPLICATIONS

- Digital equipments.
- Personal computers and peripherals.
- Measuring and testing instruments.
- Communication equipments.
- Medical equipments.

SPECIFICATIONS

Model	Rated Voltage (AC,DC)	Rated Current	Leakage Current (250V AC)	Temperature Rise	Operating Temperature(°C)
IR2-(N)02**-*	250V	2A	-	60°C max. (UL only : 45°C)	-25°C to +100°C including temperature rise. (UL Only: -25°C to +85°C)
IR2-(N)04**-*	250V	4A	-		
IR2-(N)06**-*	250V	6A	-		
IR2-(N)10**-*	250V	10A	-		
IR2-(N)***0-*	-	*	0.01mA max.	-	
IR2-(N)***C-*	-	*	0.075mA max.	-	
IR2-(N)***D-*	-	*	0.10mA max.	-	
IR2-(N)***G-*	-	*	0.15mA max.	-	
IR2-(N)***E-*	-	*	0.20mA max.	-	
IR2-(N)***1-*	-	*	0.25mA max.	-	
IR2-(N)***2-*	-	*	0.35mA max.	-	
IR2-(N)***3-*	-	*	0.50mA max.	-	

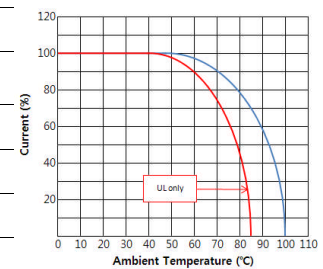

Note:

Test Voltage: 1500V AC one minute line to earth.

Insulation Resistance: 300Mohm min. at 500V DC.

Voltage Drop: 1V max. at rated current.

Weight: 80g

Inlet: Compatible with IEC 60320-1, C14

■ Model Number Construction

I	R2	N02	4	2	H
Input Connector I: IEC Connector	Special Design R2 : Screw Mounting /With Dual Fuse	Current Rating : ACrms 02 : 2amp 04 : 4amp 06 : 6amp 10 : 10amp N**: Highest permeability	Line-Line Cap.Value 2 : 0.022uF 3 : 0.033uF 4 : 0.047uF 6 : 0.068uF A : 0.1 uF B : 0.15 uF C : 0.22 uF D : 0.33 uF	Line-Gnd Cap.Value C : 330pF D : 470pF G : 680pF F : 820pF E : 1000pF 1 : 1500pF 2 : 2200pF 3 : 3300pF 0 : None	Output Terminal Style H : Faston Tab #250 S : Solder Lug

Shapes and Dimensions

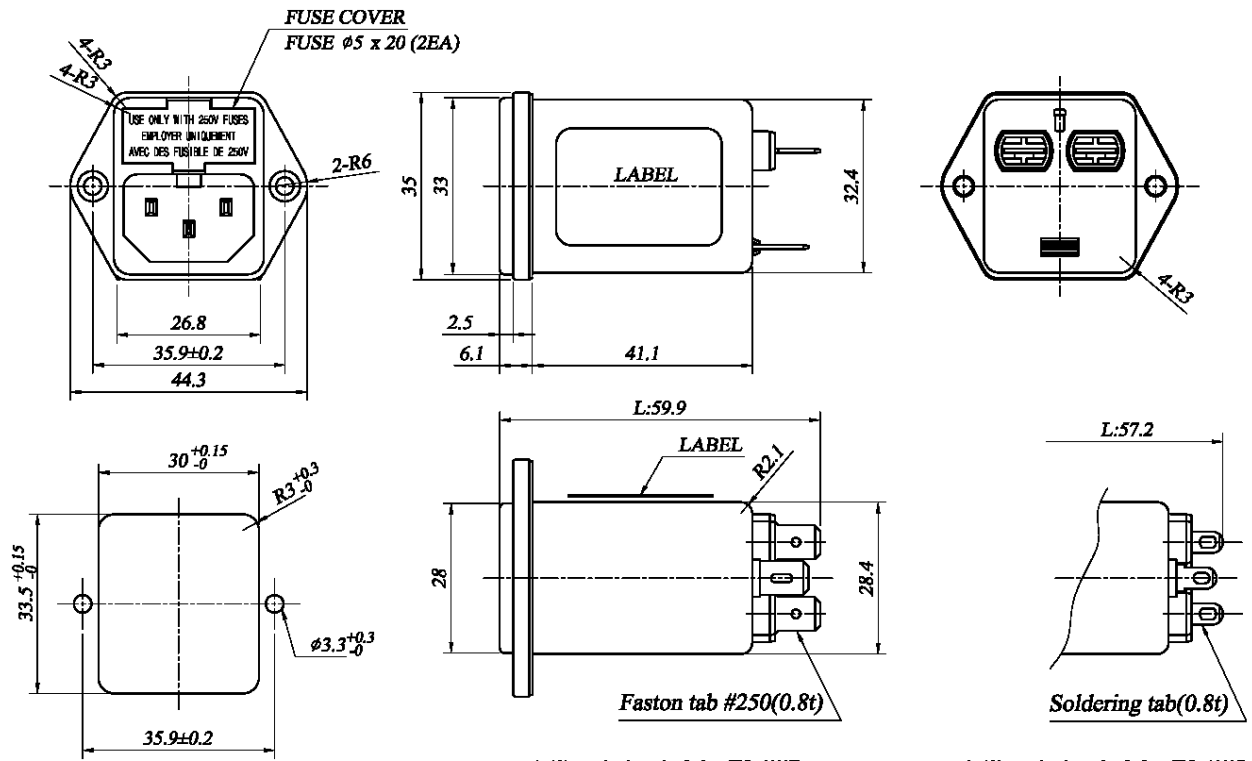

**Panel Cutout dimension
mount from backside.**

* Alternate terminal for IR2-***H

* Alternate terminal for IR2-***S

Attenuation Characteristics

●Common Mode(IR2-02/04**-*)

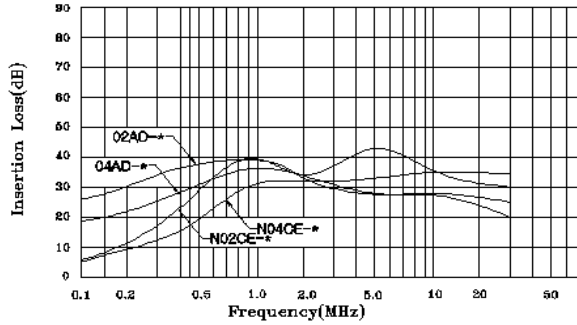

●Differential Mode(IR2-02/04**-*)

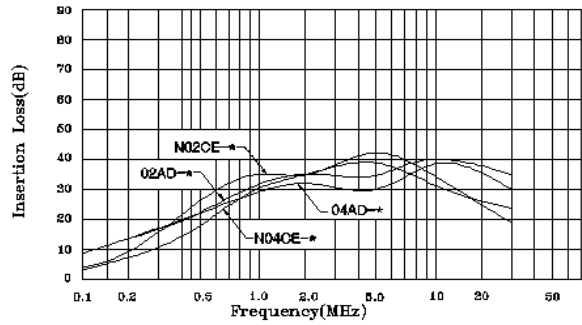

●Common Mode(IR2-06**-*)

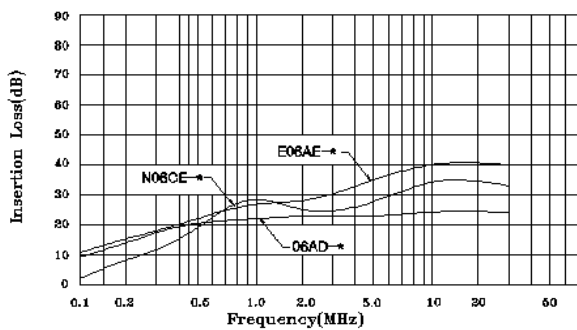

●Differential Mode(IR2-06**-*)

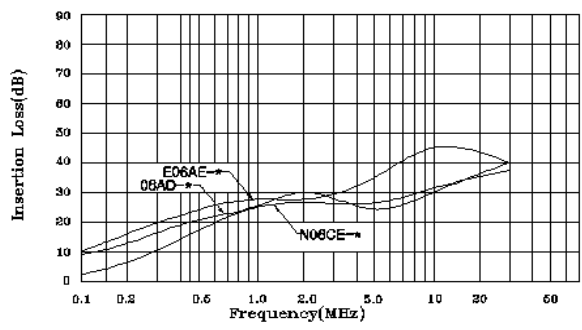

●Circuit Diagram

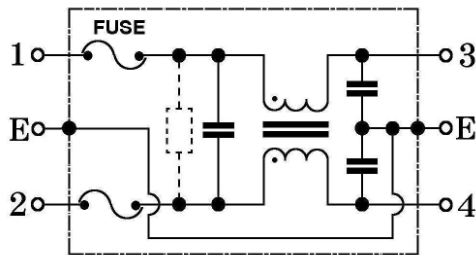

IR2-**** TYPE

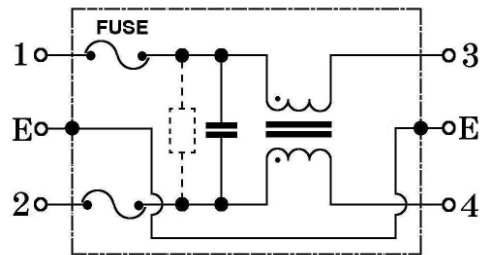

IR2-****0 TYPE

●Measurement configuration

