

AVR1 SUPER SUMO ROBOT
CODE 1109

LEVEL 3

This super sumo can be controlled to attack or retreat and ready for battle with opponent. This robot is using the AVR microcontroller, so the user can re-program into IC for getting new applications.

Technical Specifications:

- Power supply : 2 AA batteries (not included).
- Consumption : 80mA.
- PCB dimensions : 2.54 x 1.18 in. (sensor board)
2.54 x 2.70 in. (control board)

(1) ROBOT CONTROL CIRCUIT

How To Work:

The circuit is composed of 2 major parts, sensor board and control board, as shown in Fig. 1.

Sensor board have 3 sets, in set as transmitter and receiver of infrared light. Transmitter part is consist TR4 and LED INF. VR4 is used for adjust the level of infrared light. Receiver part, when photo-transistor received infrared light from LED INF, causing voltage being passed through. The more reflected light will lessen the internal resistance and give bigger passing through voltage. Less reflected light will enlarge the internal resistance and give less passing through voltage. TR1 to TR3 will work when the photo-transistor received infrared light.

Control board, at the heart of the circuit is the AVR microcontroller IC1. When below photo-transistor is not receiving infrared light (white ground), TR1 to TR3 are not working. IC1 will send the voltage to pin 12 and pin 15, causing both motor is running forward. If some below photo-transistor received infrared light (black ground), motor is running backward. For center sensor, when sensor detects the

object, IC1 will send the voltage pin 9 and pin 14, causing motor is rotate faster. IDE port is used for connect AVR programmer.

Circuit Assembling:

The PCB will be divided into two boards, AVR1-1 for circuit controlling and Body set for body, motor gear, wheel and battery holder assembling.

The AVR1-1 circuit assembling has been shown in Fig 2. It is recommended to assemble the circuit starting with a less height component i.e. diodes, resistor, electrolytic capacitors and transistors etc. Be careful while assembling and check for the matching of PCB poles and components before soldering as shown in Fig 3. For IDE port, press the pin of IDE port to be level with the black plastic before soldering. Use a max. 40W solder and soldering tin with a tin and lead ratio of 60/40 together with a joint solution inside. Recheck the assembled circuit for your own confidence. Better use a lead sucker or a lead wire absorber in case of component misplacing to protect PCB from damage.

The Body set is to be assembled as shown in the next page.

Testing:

When the two circuit boards have been completely assembled. Insert four AA batteries into the battery holder. Then adjust VR1 to VR4 to the middle side and slide switch SW to "on" position. LED at sensor board is lighted on. Lay down the assembled robot on the test paper. Robot is running inside the black frame. The robot will backward and turn when below sensor detecting the black line. But front sensor detects the any object, the robot will run forward and running up the speed to bump.

VR1 to VR3 will act as sensitivity of photo-transistor. Adjust the left hand side for decreasing sensitivity and to the right hand side for increasing sensitivity. VR4 will act as level of infrared light.

SW1 is used for set the speed of robot. When you want to setting the speed, slide switch SW to "off" position then push and hold SW1. Slide SW to "on" position. Seeing LED at control board. LED will chasing step by step. LED1 is slowly speed and LED4 is higher speed.

Figure 2. AVR1-1 and SENSOR1-1 Circuit Board Assembling

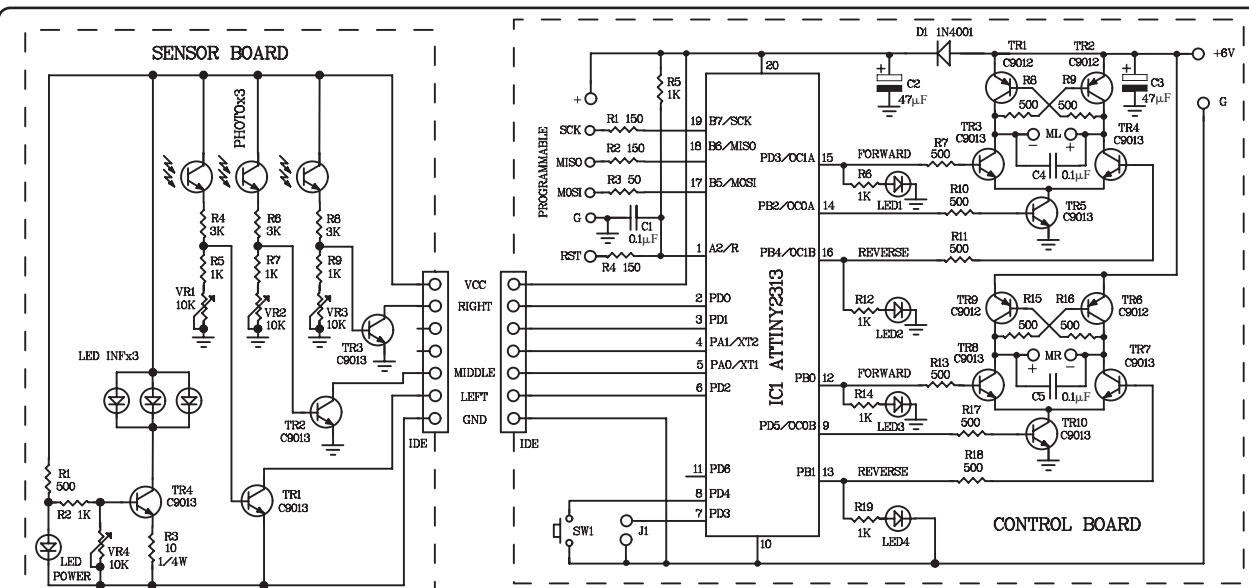
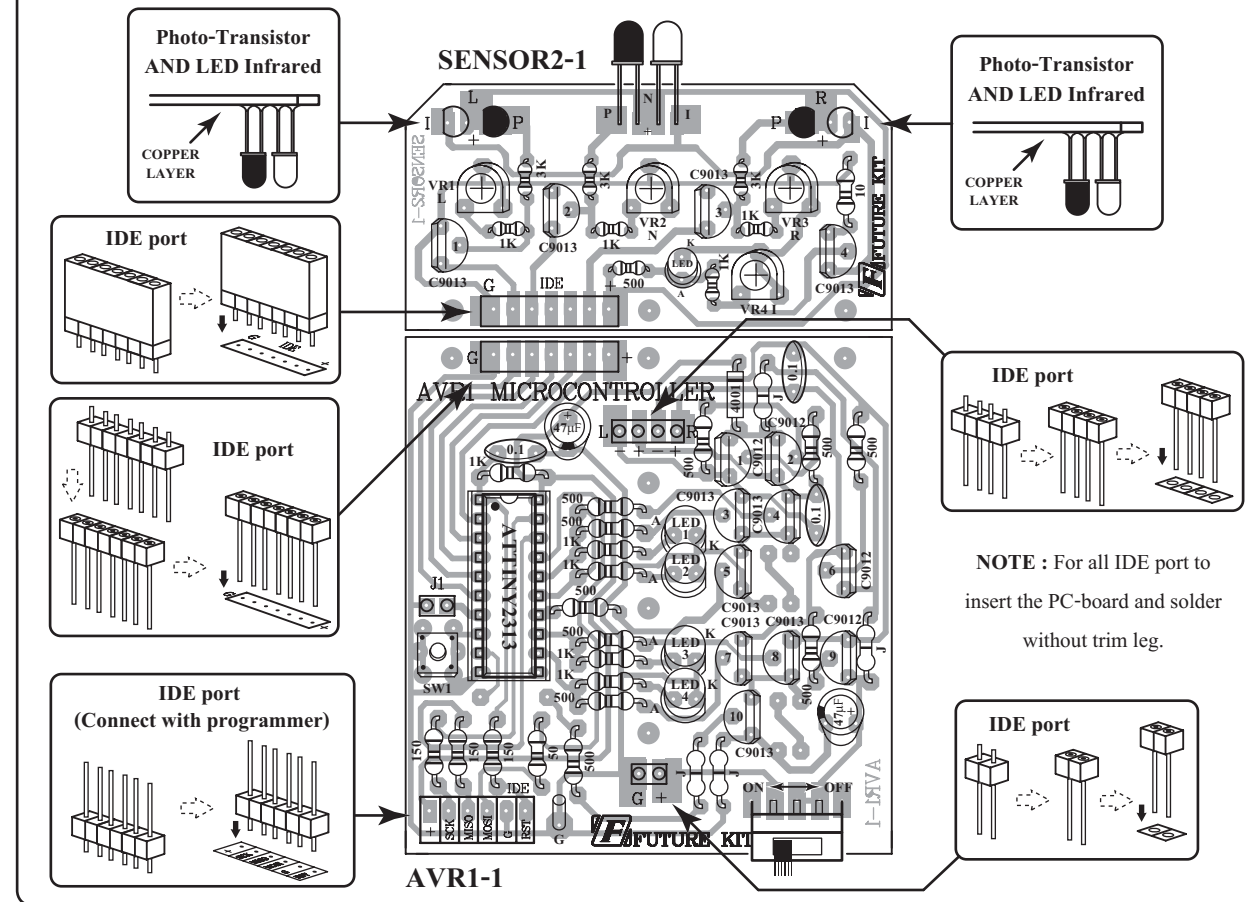

Figure 1. AVR1 Super Sumo Robot Circuit

SENSOR BOARD

RESISTOR 1/8W

- R1 500Ω - green-black-brown-gold
- R2,R5,R7,R9 1kΩ - brown-black-red-gold
- R4,R6,R8 3kΩ - orange-black-red-gold

RESISTOR 1/4W

- R3 10Ω - brown-black-black-gold

TRIMMER POTENTIOMETERS

- VR1-VR4 = 10kΩ or 103

CONTROL BOARD

RESISTOR 1/4W

- R1,R2,R4 150Ω - brown-green-brown-gold
- R3 50Ω - green-black-black-gold
- R5,R6,R12,R14,R19 1kΩ - brown-black-red-gold
- R7-R11,R13,R15-R18 500Ω - green-black-brown-gold

Troubleshooting:

As the circuit has only a few components, the main cause of troubles will come from component misplacing and defaulted soldering. When found out that the circuit does not work, check for the proper component placings and various soldering points.

Figure 3. Components Installing

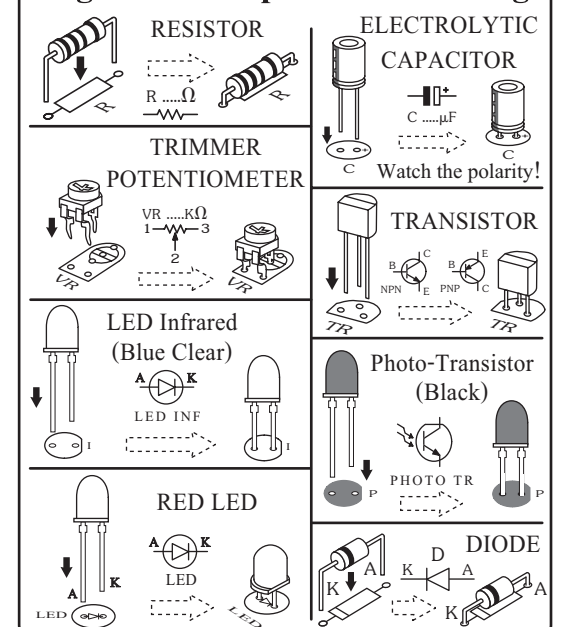

(2) ROBOT BODY

Assembling Steps of the Body set.

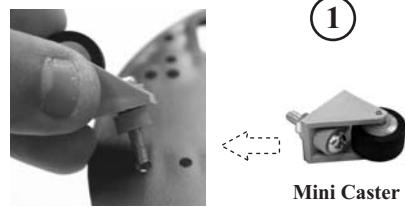

①

Mini Caster

Fix a mini caster wheel set to the Body set with using a 12 mm. bolt as a holder.



②

Install battery holder to body robot with flat head nut 2.5x10 and nut M2.5.

Flat head nut
2.5x10 and NUT M2.5

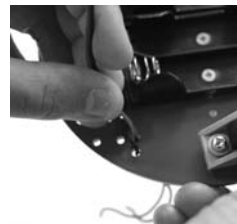

③

Insert the electric wire battery holder into body robot.

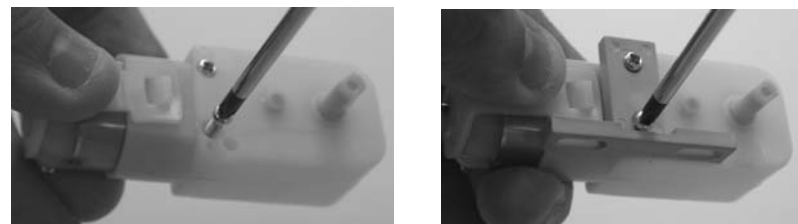

④

Take off the both screw of motor gear and then mount the motor lock. Secure with the both screw of motor gear.

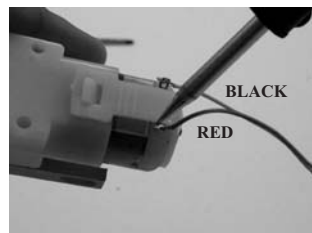

⑤

Solder electric wire at motor pole with red wire solders at left hand side and black wire solders at right hand side.

BLACK
RED

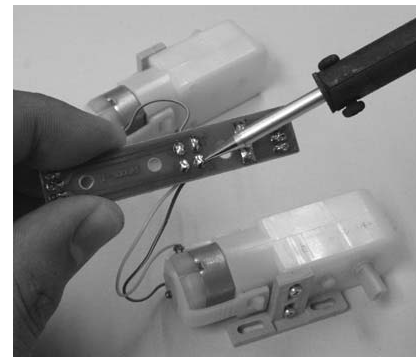

⑥

Solder motor wire to BR002-1 PC-board. Red wire is positive pole and black wire is negative pole. Character "L" is left motor gear and "R" is right motor gear.



⑦

Mount motors, each with two #4 x 1/4" screws

Screw 4x1/4

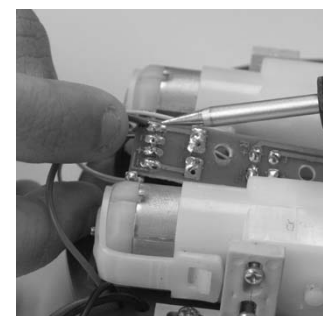

⑧

Solder battery holder wire to BR002-1 PC-board at B1 and B2. Red wire is positive pole and Black is negative pole.



⑨

Mount BR002-1 PC-board into body robot and secure them with two #2 x 1/4" screws.



Screw 2x1/4

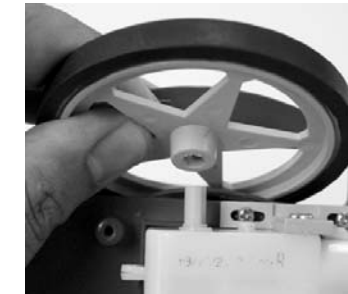

⑩



Screw 4x1/4

Install the wheels onto the shaft of the gear motors and secure them with the remaining two #4 x 1/4" pointy screws.



⑪



Sensor Board



Flat head nut
2.5x10 and NUT M2.5

⑫



Install the plastic pin hold to body robot with flat head nut 2.5x10 and nut M2.5. After then install the front plate to the plastic pin hold with flat head nut 2.5x10 and nut M2.5.



Screw 2x1/4

⑬



Mount sensor board into body robot and secure with two #2 x 1/4" screws.

⑭



Install the control board into body robot.

⑮



Screw 4x3/4

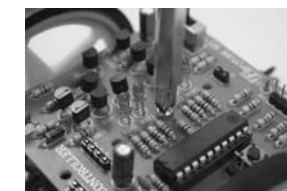

Secure control board with two #4 x 3/4" screws.

⑯

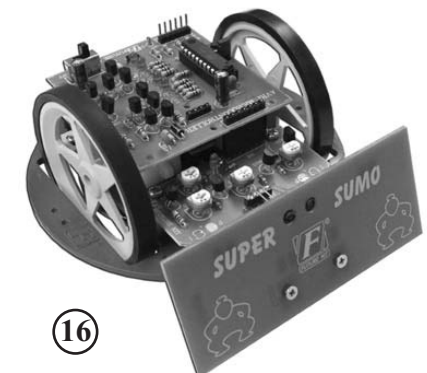

The robot is prompt working and playing.



FOR TESTING FK1109

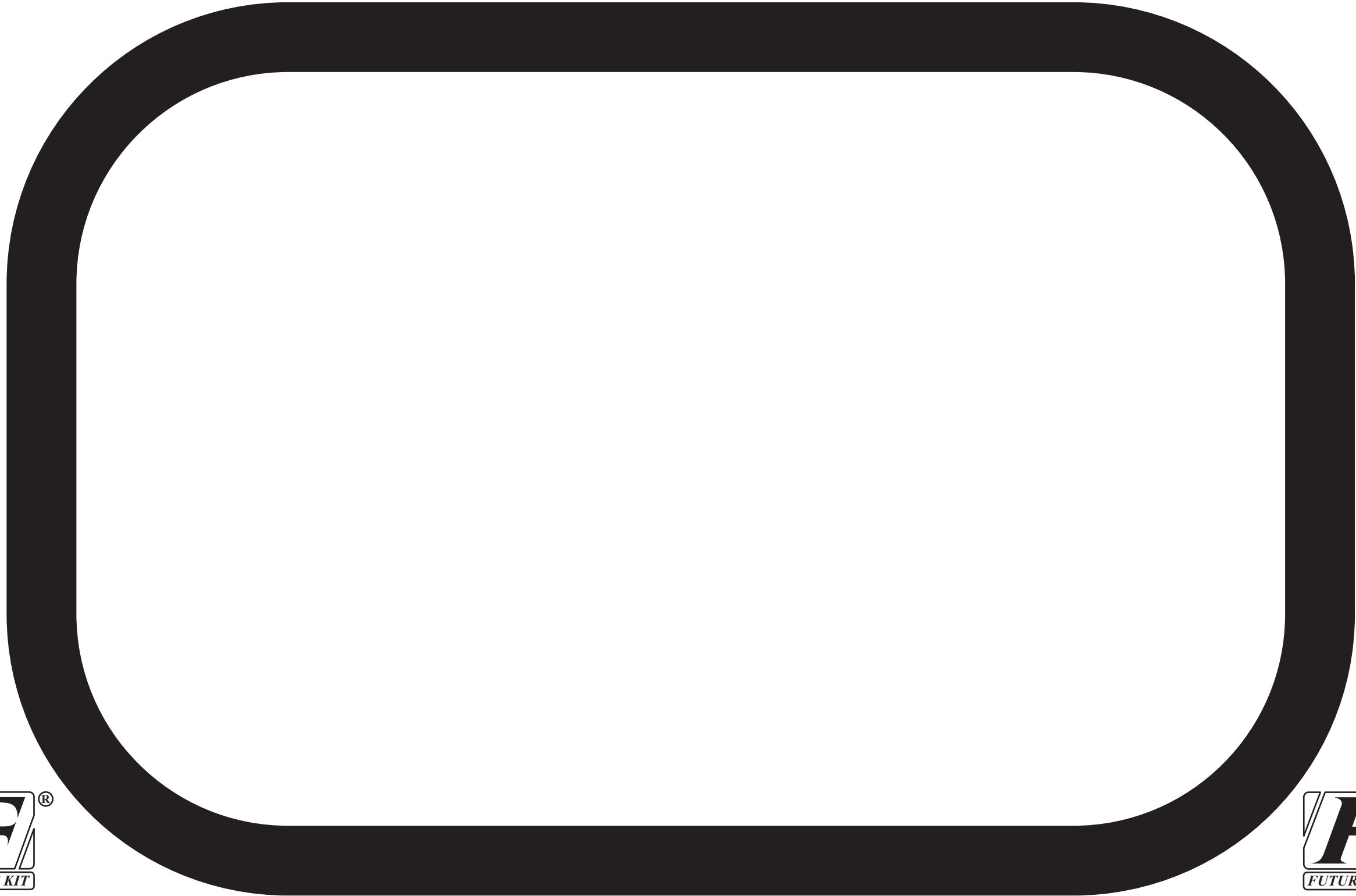

FOR TESTING FK1109