

Total solder points: 87
Difficulty level: *beginner* 1 2 3 4 5 *advanced*

MULTIFUNCTION CAR COURTESY LIGHT

K3500

Never look for the ignition
switch in the dark again.

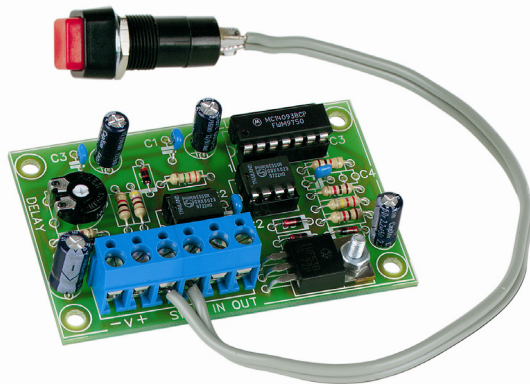

Specifications

- switch-off delay: adjustable for 0 to 60 seconds.
- power supply: 12-15Vdc.
- power consumption: 13mA.
- PCB dimensions: 45 x 70mm (1.8" x 2.8").



Specifications:

- ☑ Keeps the interior illumination on after closing the car door.
- ☑ One push button operation for :
 - reset delay time.
 - Switch on illumination.
 - Switch off illumination.
- ☑ Simple connection to almost any car.
- ☑ Push button included.

Features:

- switch-off delay: adjustable for 0 to 60 seconds.
- power supply: 12-15Vdc.
- power consumption: 13mA.
- PCB dimensions: 45 x 70mm (1.8" x 2.8").

1. Assembly (Skipping this can lead to troubles !)

Ok, so we have your attention. These hints will help you to make this project successful. Read them carefully.

1.1 Make sure you have the right tools:

- A good quality soldering iron (25-40W) with a small tip.
- Wipe it often on a wet sponge or cloth, to keep it clean; then apply solder to the tip, to give it a wet look. This is called 'thinning' and will protect the tip, and enables you to make good connections. When solder rolls off the tip, it needs cleaning.
- Thin raisin-core solder. Do not use any flux or grease.
- A diagonal cutter to trim excess wires. To avoid injury when cutting excess leads, hold the lead so they cannot fly towards the eyes.
- Needle nose pliers, for bending leads, or to hold components in place.
- Small blade and Phillips screwdrivers. A basic range is fine.

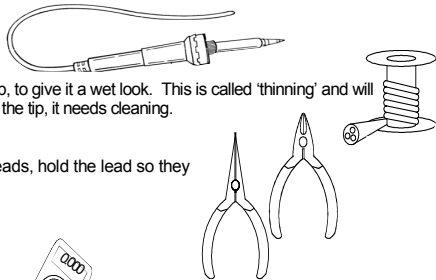

For some projects, a basic multi-meter is required, or might be handy

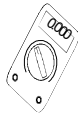

1.2 Assembly Hints :

- ⇒ Make sure the skill level matches your experience, to avoid disappointments.
 - ⇒ Follow the instructions carefully. Read and understand the entire step before you perform each operation.
 - ⇒ Perform the assembly in the correct order as stated in this manual
 - ⇒ Position all parts on the PCB (Printed Circuit Board) as shown on the drawings.
 - ⇒ Values on the circuit diagram are subject to changes.
 - ⇒ Values in this assembly guide are correct*
 - ⇒ Use the check-boxes to mark your progress.
 - ⇒ Please read the included information on safety and customer service
- * Typographical inaccuracies excluded. Always look for possible last minute manual updates, indicated as 'NOTE' on a separate leaflet.

1.3 Soldering Hints :

1- Mount the component against the PCB surface and carefully solder the leads

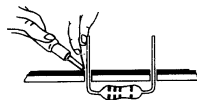

2- Make sure the solder joints are cone-shaped and shiny

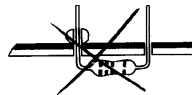
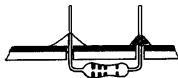

3- Trim excess leads as close as possible to the solder joint

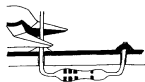

REMOVE THEM FROM THE TAPE ONE AT A TIME !

DO NOT BLINDLY FOLLOW THE ORDER OF THE COMPONENTS ON THE TAPE. ALWAYS CHECK THEIR VALUE ON THE PARTS LIST!

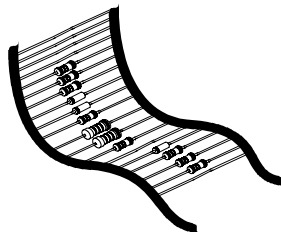

1. Jumper

J

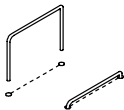

2. Diodes. Watch the polarity !

- D1 : 1N4148
- D2 : 1N4148
- D3 : 1N4148
- D4 : 1N4148
- D5 : 1N4007

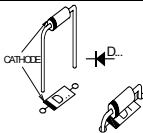

3. Resistors

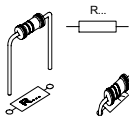

- R1 : 1K (1-0-2-B)
- R2 : 1K (1-0-2-B)
- R3 : 1K (1-0-2-B)
- R4 : 470 (4-7-1-B)

- R5 : 3M3 (3-3-5-B)
- R6 : 330K (3-3-4-B)
- R7 : 10K (1-0-3-B)
- R8 : 10K (1-0-3-B)

4. IC sockets, Watch the position of the notch !

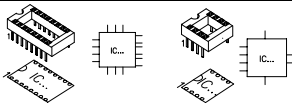

- IC1 : 8P
- IC2 : 8P
- IC3 : 14P

5. Capacitors.

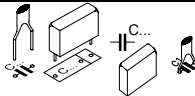

- C1 : 10nF (103)
- C2 : 10nF (103)
- C3 : 100nF (104)
- C4 : 100nF (104)

6. Resistor trimmer

RV1 : 1M ohm

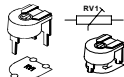

7. Transistor.

T1 : IRF530

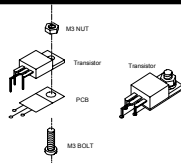

8. Electrolytic Capacitors. Watch the polarity !

- C5 : 2,2 μ F
- C6 : 47 μ F
- C7 : 47 μ F
- C8 : 100 μ F

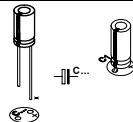

9. Screw connectors

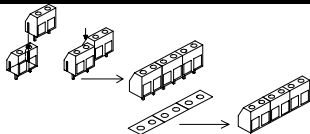

☐ J1 : 3 x 2P

10. IC, Check the position of the notch!

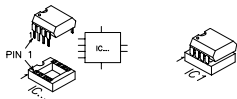

☐ IC1 : NE555

☐ IC2 : NE555

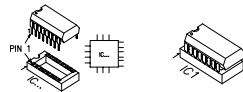

☐ IC3 : CD4093

11. Connection

- Install the push button within driver's reach and connect it to the screw connector (marked SW1).
- Interrupt the wire to the door contact (driver's door) and connect the wire to the point marked "OUT".
- Connect the "+" connection tot the car's +12V.
 - ☞ Make sure that there is tension on this connection constantly!
- Connect the "-" connection to the car's chassis.

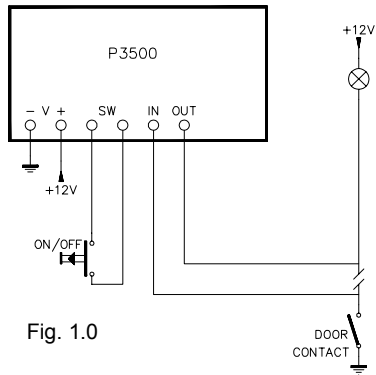

Fig. 1.0

12. Test

Now you can switch the light on or off, by operating the push button.
As a battery saving measure, the light will automatically be switched on after about 5 minutes.

- Turn the trimmer to its centre position.
- Open en close the driver's door : normally the interior light should burn now, and extinguish again after about 30 seconds.

This delay can be made longer or shorter by turning the trimmer.

13. PCB layout.

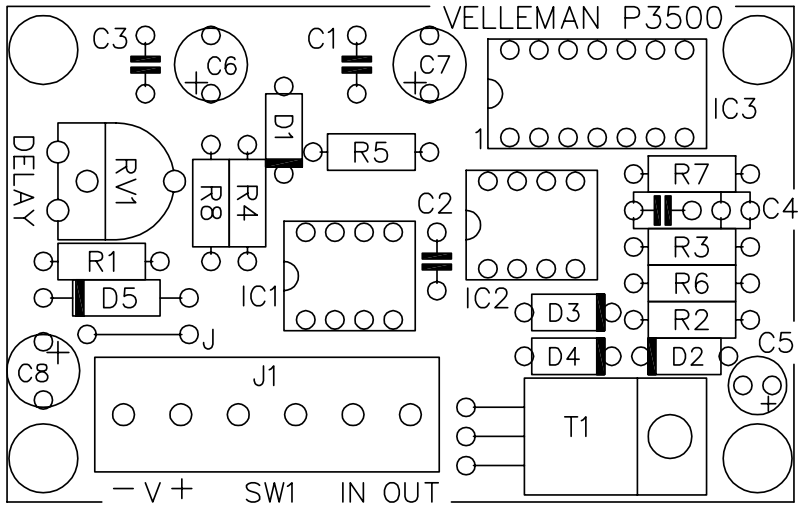

14. Diagram

