

## BASE UNIT for HOME MODULAR LIGHT SYSTEM

Create your own domestic-modular light control system.

Total solder points: 234

Difficulty level: *beginner* 1  2  3  4  5  *advanced*

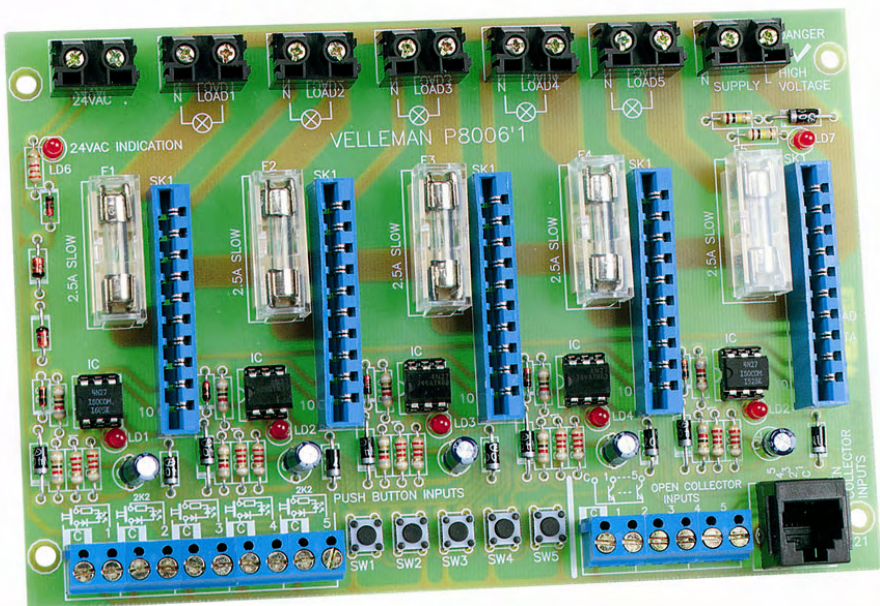

# K8006



**VELLEMAN NV**  
**Legen Heirweg 33**  
**9890 Gavere**  
**Belgium Europe**  
**[www.velleman.be](http://www.velleman.be)**  
**[www.velleman-kit.com](http://www.velleman-kit.com)**

## Features :

- ☑ Create your own domestic modular light control system.
- ☑ For use with optional dimmer module (K8007), timer module (K8008), relay output module (K8027) and slow on-off dimmer (K8029).
- ☑ Bus system holds up to five plug-in units.
- ☑ Optically insulated push button inputs.
- ☑ Can be controlled with open collector circuits (ex. K8000 computer interface card or with 15-channel IR receiver K8050, K6711).
- ☑ Local control pushbuttons included.
- ☑ LED power and mains indicator.
- ☑ LED operation indicator for each channel.
- ☑ Low-voltage control circuit for extra safety.
- ☑ Each plug-in slot is fused.
- ☑ Includes 10 LED's for pushbutton illumination.
- ☑ A custom enclosure for rail mounting is available (B8006).

## Specifications

- Five separate channels.
- Maximum output : 2.5A per channel (fuse protected).
- Push button control current: 150mA.
- Open collector control current: 35mA DC.
- Power supply: 24VAC / 300mA.
- Supply voltage for modules: 110V to 240VAC.
- PCB dimensions: 107 x 160 x 70mm/ 4.2"x6.3"x2.8".

## OPTIONS

- K8007 : Dimmer module.
- K8008 : Timer module.
- K8027 : Relay module.
- K8029 : Slow on/off dimmer.
- K8050 : 15-channel IR receiver.
- K8049 : 15-channel IR transmitter.
- K8051 : 15-channel IR remote stick.
- B8006 : DIN-rail module (enclosure).

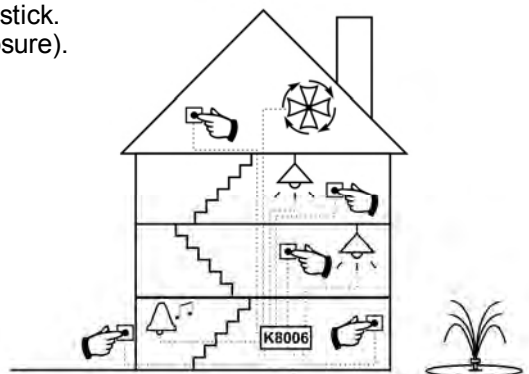

## 1. Assembly (Skipping this can lead to troubles !)

Ok, so we have your attention. These hints will help you to make this project successful. Read them carefully.

### 1.1 Make sure you have the right tools:

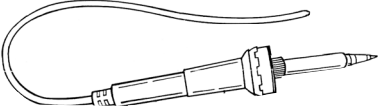
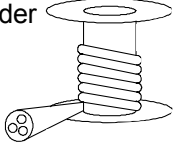
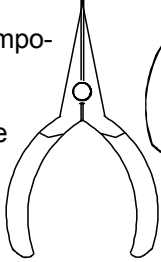
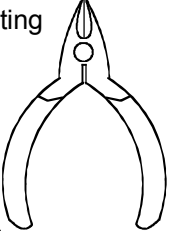
- A good quality soldering iron (25-40W) with a small tip. 
- Wipe it often on a wet sponge or cloth, to keep it clean; then apply solder to the tip, to give it a wet look. This is called 'thinning' and will protect the tip, and enables you to make good connections. When solder rolls off the tip, it needs cleaning.
- Thin raisin-core solder. Do not use any flux or grease. 
- A diagonal cutter to trim excess wires. To avoid injury when cutting excess leads, hold the lead so they cannot fly towards the eyes.
- Needle nose pliers, for bending leads, or to hold components in place. 
- Small blade and Phillips screwdrivers. A basic range is fine. 



**For some projects, a basic multi-meter is required, or might be handy**

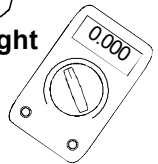

### 1.2 Assembly Hints :

- ⇒ Make sure the skill level matches your experience, to avoid disappointments.
- ⇒ Follow the instructions carefully. Read and understand the entire step before you perform each operation.
- ⇒ Perform the assembly in the correct order as stated in this manual
- ⇒ Position all parts on the PCB (Printed Circuit Board) as shown on the drawings.
- ⇒ Values on the circuit diagram are subject to changes.
- ⇒ Values in this assembly guide are correct\*

- ⇒ Use the check-boxes to mark your progress.
- ⇒ Please read the included information on safety and customer service

\* Typographical inaccuracies excluded. Always look for possible last minute manual updates, indicated as 'NOTE' on a separate leaflet.

**1.3 Soldering Hints :**

**1-** Mount the component against the PCB surface and carefully solder the leads

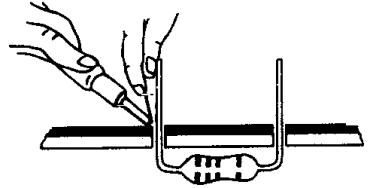

**2-** Make sure the solder joints are cone-shaped and shiny

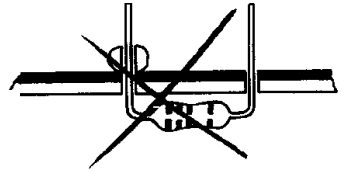
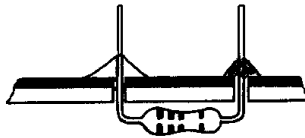

**3-** Trim excess leads as close as possible to the solder joint

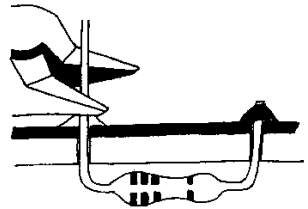

**DO NOT BLINDLY FOLLOW THE ORDER OF THE COMPONENTS ONTO THE TAPE. ALWAYS CHECK THEIR VALUE ON THE PARTS LIST!**

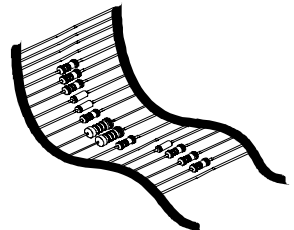

### 1. Diodes (check the polarity)

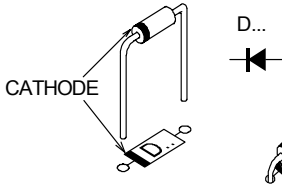

- D1 : 1N4148
- D2 : 1N4148
- D3 : 1N4148
- D4 : 1N4148
- D5 : 1N4148
- D6 : 1N4148
- D7 : 1N4007
- D8 : 1N4007
- D9 : 1N4007
- D10 : 1N4007
- D11 : 1N4007
- D12 : 1N4007
- D13 : 1N4007
- D14 : 1N4007
- D15 : 1N4007
- D16 : 1N4007
- D17 : 1N4007

### 2. Zener diodes (check the polarity)

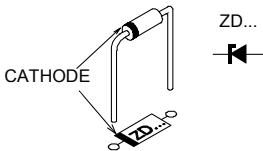

- ZD1 : 47V / 1,3W
- ZD2 : 47V / 1,3W

### 3. 1/4W Resistor.

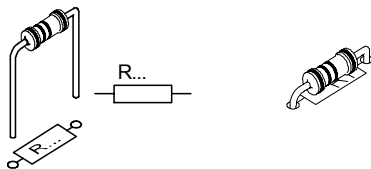

- R1 : 3K3 (3 - 3 - 2 - B)

### 4. 1/2W Resistors.

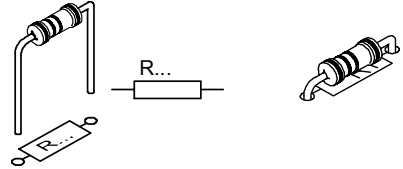

- R2 : 180 (1 - 8 - 1 - B - 9)
- R3 : 180 (1 - 8 - 1 - B - 9)
- R4 : 2K2 (2 - 2 - 2 - B - 9)
- R5 : 2K2 (2 - 2 - 2 - B - 9)
- R6 : 180 (1 - 8 - 1 - B - 9)
- R7 : 180 (1 - 8 - 1 - B - 9)
- R8 : 2K2 (2 - 2 - 2 - B - 9)
- R9 : 2K2 (2 - 2 - 2 - B - 9)
- R10 : 180 (1 - 8 - 1 - B - 9)
- R11 : 180 (1 - 8 - 1 - B - 9)
- R12 : 2K2 (2 - 2 - 2 - B - 9)
- R13 : 2K2 (2 - 2 - 2 - B - 9)
- R14 : 180 (1 - 8 - 1 - B - 9)
- R15 : 180 (1 - 8 - 1 - B - 9)
- R16 : 2K2 (2 - 2 - 2 - B - 9)
- R17 : 2K2 (2 - 2 - 2 - B - 9)
- R18 : 180 (1 - 8 - 1 - B - 9)
- R19 : 180 (1 - 8 - 1 - B - 9)
- R20 : 2K2 (2 - 2 - 2 - B - 9)
- R21 : 2K2 (2 - 2 - 2 - B - 9)
- R22 : 100K (1 - 0 - 4 - B - 9)
- R23 : 100K (1 - 0 - 4 - B - 9)

### 5. Pushbuttons

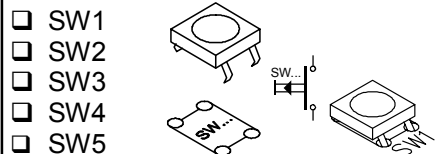

### 6. IC sockets

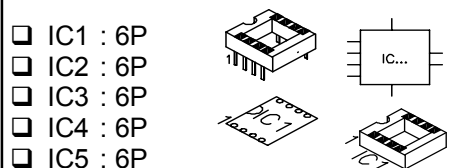

- IC1 : 6P
- IC2 : 6P
- IC3 : 6P
- IC4 : 6P
- IC5 : 6P

**7. LEDs. Watch the polarity!**

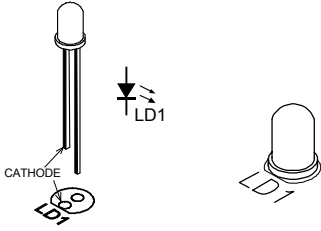

- LD1
  - LD2
  - LD3
  - LD4
  - LD5
  - LD6
  - LD7
- } 3mm RED

**8. PCB Edge Connectors (Watch the orientation!)**

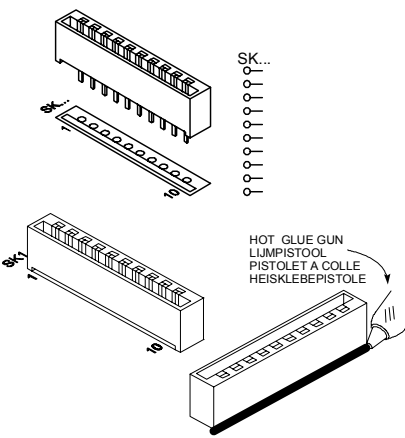

- SK1 : 10 POLE
- SK2 : 10 POLE
- SK3 : 10 POLE
- SK4 : 10 POLE
- SK5 : 10 POLE

**9. PC Terminal blocks (Slide the terminal blocks, one into each other)**

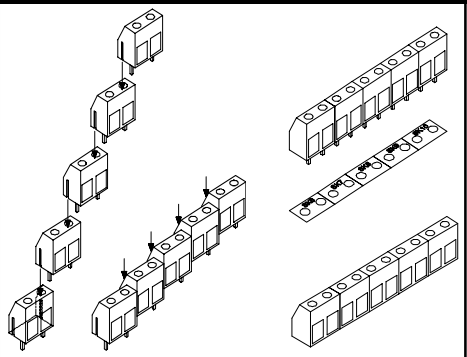

- SK6 to SK10 : 2P+2P+2P+2P+2P

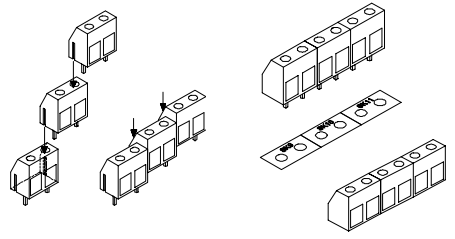

- SK11 to SK13 : 2P+2P+2P

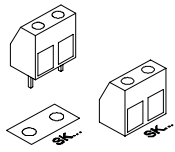

- SK14: 2-POLE (wide)
- SK15: 2-POLE (wide)
- SK16: 2-POLE (wide)
- SK17: 2-POLE (wide)
- SK18: 2-POLE (wide)
- SK19: 2-POLE (wide)
- SK20: 2-POLE (wide)

### 10. Fuse Holder + Fuse

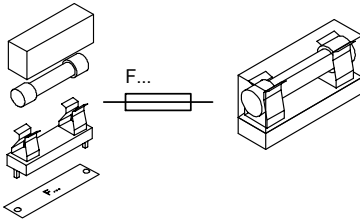

- F1 : 2,5A SLOW
- F2 : 2,5A SLOW
- F3 : 2,5A SLOW
- F4 : 2,5A SLOW
- F5 : 2,5A SLOW

### 11. Electrolytic capacitors. Check the polarity !

- C1 : 22µF/50V
- C2 : 22µF/50V
- C3 : 22µF/50V
- C4 : 22µF/50V
- C5 : 22µF/50V

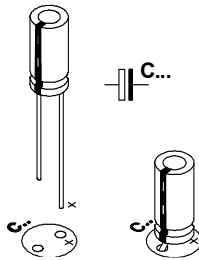

### 12. Modular Jack

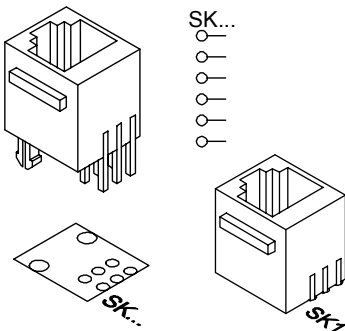

- SK21 : 6-POLE

### 13. Insert the OPTO Coupler into the socket (Watch the position of the notch!)

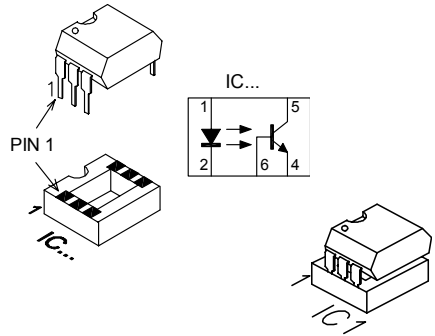

- IC1 : 4N27, TIL111 or eq.
- IC2 : 4N27, TIL111 or eq.
- IC3 : 4N27, TIL111 or eq.
- IC4 : 4N27, TIL111 or eq.
- IC5 : 4N27, TIL111 or eq.



### 14. Testing the Unit



**CAUTION: MOST PARTS OF THE CIRCUIT CARRY DANGEROUS VOLTAGES (MAINS)! OBSERVE ALL SAFETY REQUIREMENTS THAT MIGHT APPLY !**

- First, make sure to apply an extra layer of solder on all thinned PCB tracks because these have to handle high currents.
- Connect a light bulb rated for the wall outlet voltage (mains) to **LOAD 1**.
- Insert a dimmer module (K8007) or timer module (K8008) into the first slot (mind the direction, the components must point to the left).
- Connect a 24VAC/300mA source (e.g. transformer) to the **24VAC** connector. LD6 will light.
- Connect the 110-240V mains to the **SUPPLY Neutral** and **Live** connector. LD7 will light.

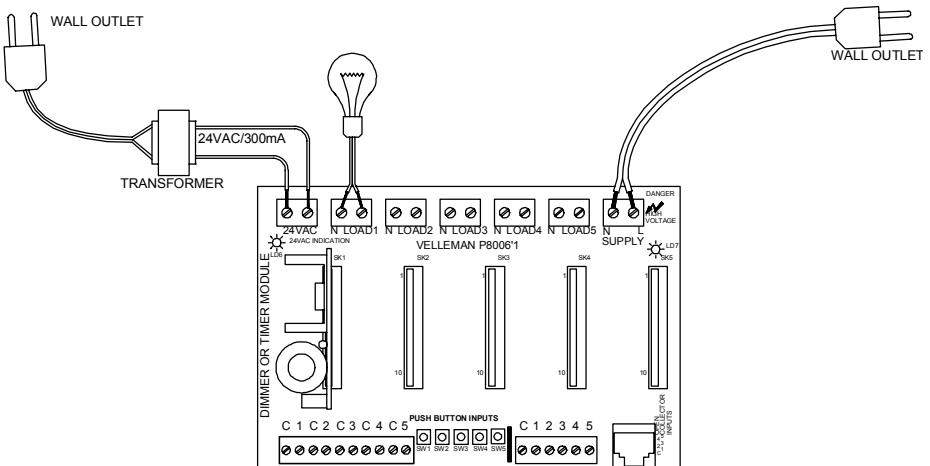

Push button SW1. The module will be activated, and the light bulb will light. For dimmer/timer module operation details, please check their manuals. All remaining slots must be tested in the same way. Disconnect the mains when removing modules or wiring.

## 15. Final Connection

Choose a suitable location for the unit. Probably, the best location is near the fuse box. An optional enclosure (B8006) is available, for safe installation of the unit on a DIN rail. Whatever enclosure you use, make sure to provide sufficient airflow, as the dimmer modules might run hot during use. If you choose the optional B8006 enclosure, drill a number of ventilation holes in the top and bottom part of the cover lid.

*The drawing below shows a connection example.*

**Make sure your wiring complies with the local safety requirements. If doubt, consult a licensed technician !**

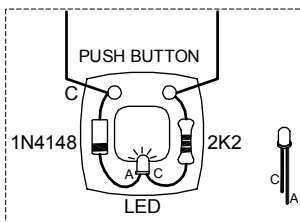
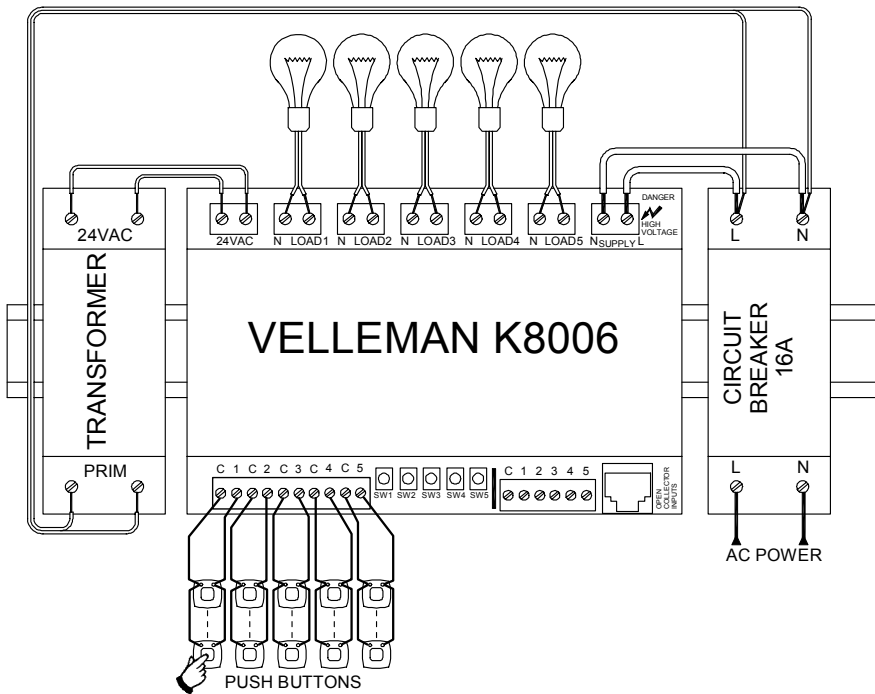

Fig. 1.0

**REMARK:** 10 LEDs are provided, together with diodes and resistors, to allow push button illumination. Do not use more than 5 illuminated push buttons per channel.

### 16. Interfacing with open collector outputs

The drawing below shows a connection example with open collector outputs (e.g. K8000 computer interface board, or K8050 (K6711) remote control receiver). The open collector inputs are also available via modular connector SK19, which allows easy and fast connection to a control circuit.

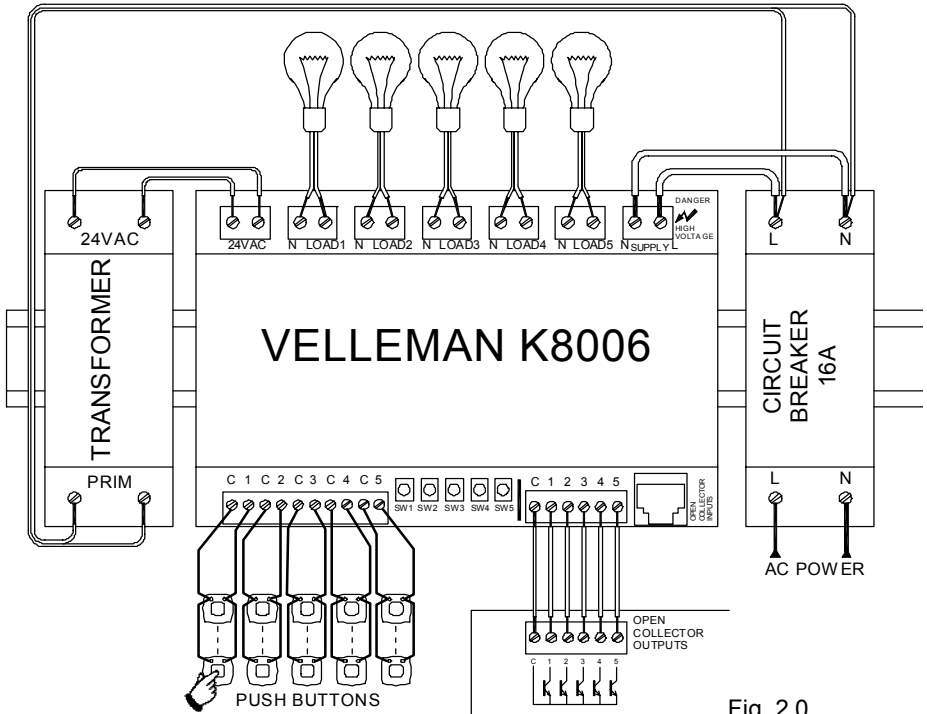
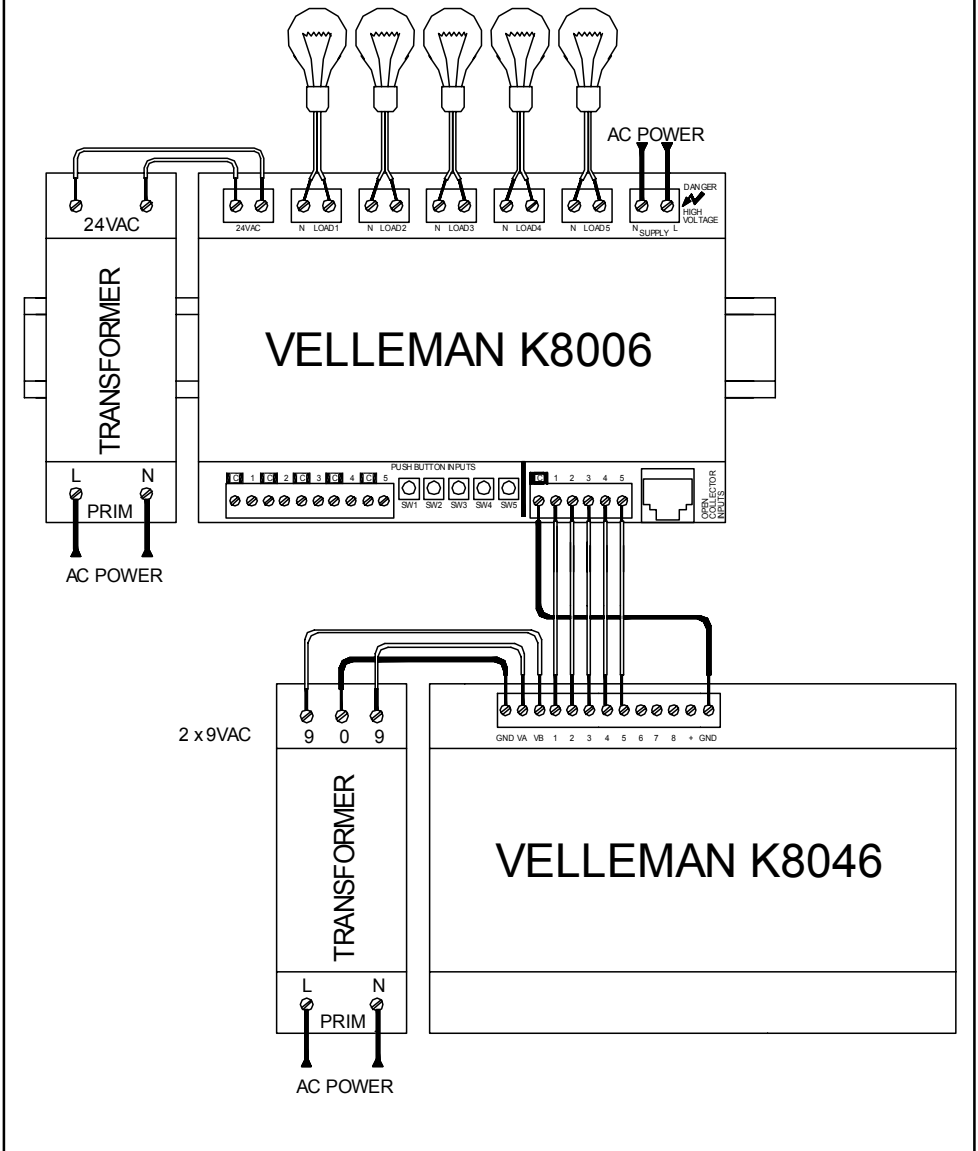
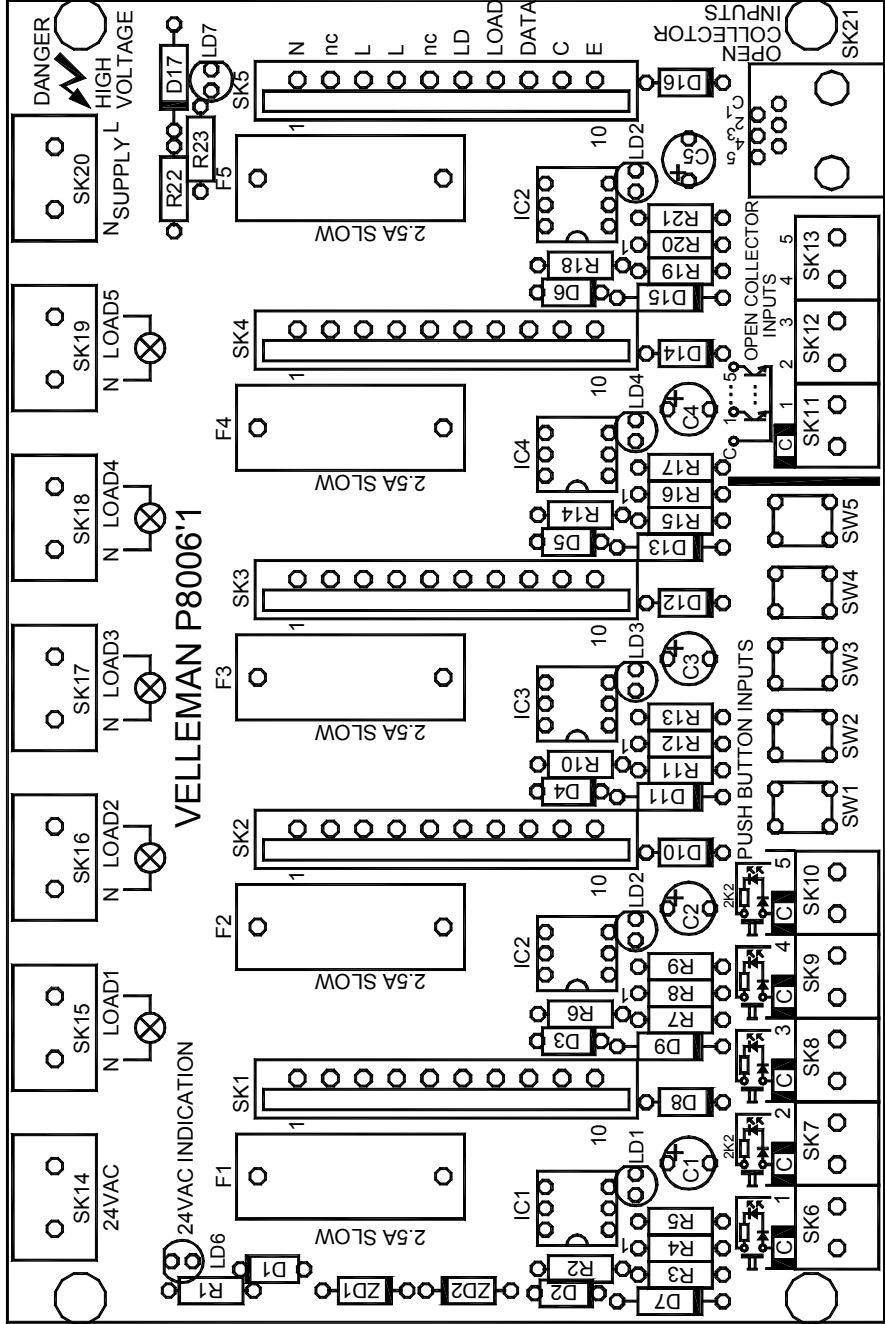

Fig. 2.0

**17. Home modular light system controlled by touchscreen (K8046)**



18. PCB Layout



19. Diagram

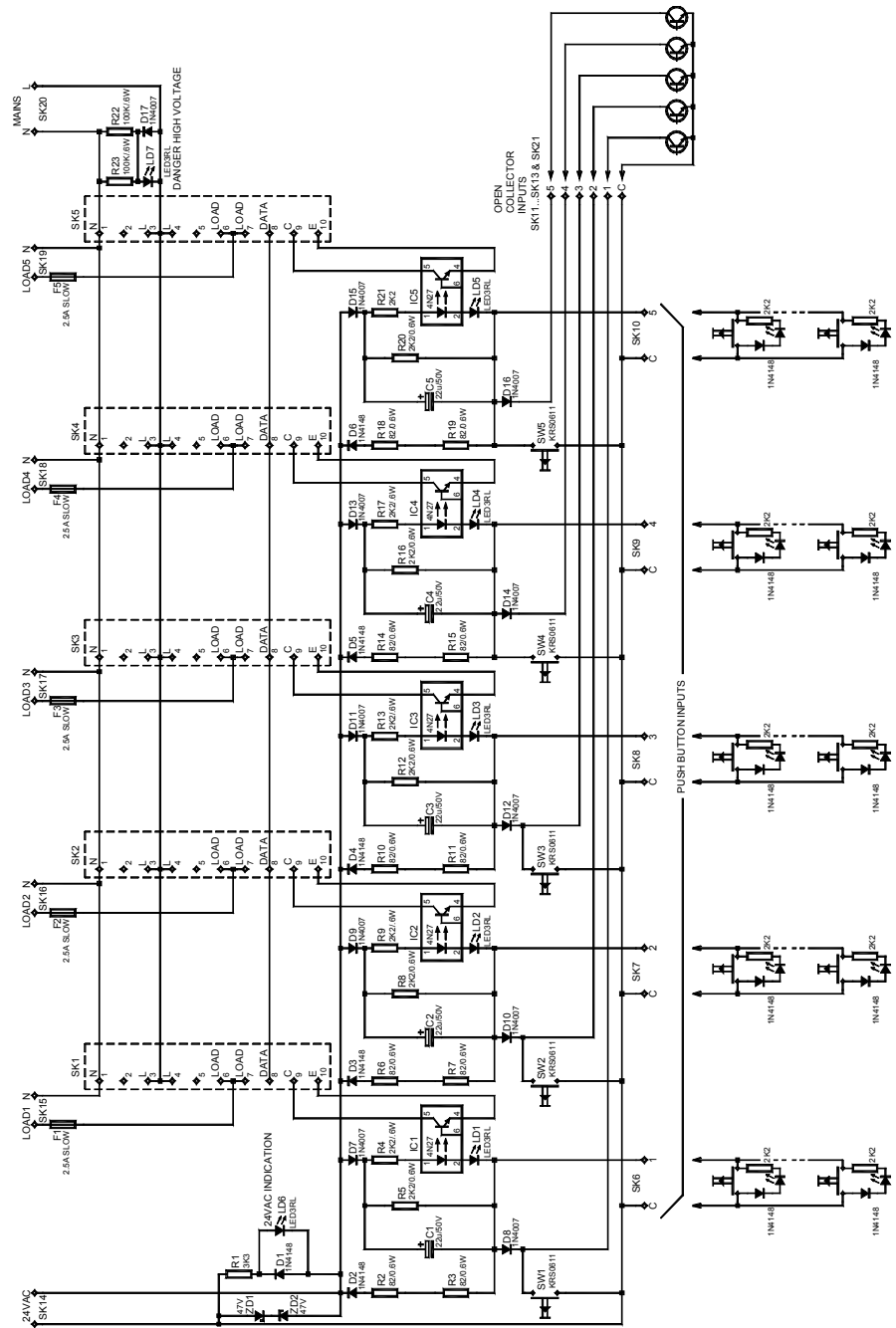



# DOMOTIC SYSTEM



VELBUS.EU

**VELLEMAN KIT NV**  
**Legen Heirweg 33**  
**9890 Gavere**  
**Belgium Europe**  
Info ? : <http://www.velleman.be>

Modifications and typographical errors reserved - © Velleman nv.  
H8006IP'2 - 2004 - rev.1

