

Total solder points: 85
Difficulty level: *beginner* 1 2 3 4 5 *advanced*

MULTIFUNCTION RELAY SWITCH

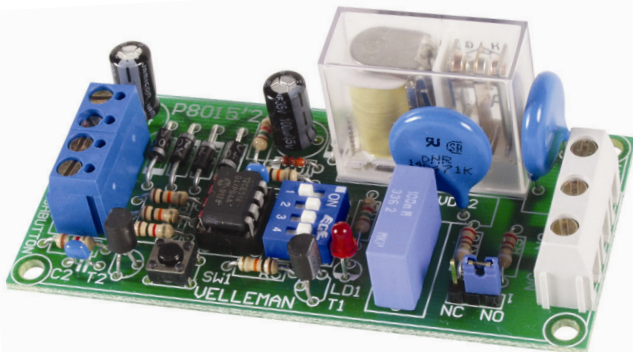

K8015

14 Different functions including timers,
switching, flashing, interval, random
switching,

Features:

- ☑ 14 different functions including timers, switching, flashing, interval, random switching, ...
- ☑ Two pre-programmed delays.
- ☑ Learning mode for delays of 2s up to 12 days.
- ☑ EEPROM for delay time storage in case of power failure.
- ☑ On-board transient filter for the relay contacts.
- ☑ Suitable for control of incandescent lighting, halogen lighting, fluorescent lighting, fans, valves, buzzers, ...

Specifications:

- Operating voltages : 9-12 VAC or 12 VDC.
- Max. load : 5A (1100W/230V; 550W/115V).
- Dimensions pcb (wxdxh): 65 x 57 x 25mm.



1. Assembly (Skipping this can lead to troubles !)

Ok, so we have your attention. These hints will help you to make this project successful. Read them carefully.

1.1 Make sure you have the right tools:

- A good quality soldering iron (25-40W) with a small tip.
- Wipe it often on a wet sponge or cloth, to keep it clean; then apply solder to the tip, to give it a wet look. This is called 'thinning' and will protect the tip, and enables you to make good connections. When solder rolls off the tip, it needs cleaning.
- Thin raisin-core solder. Do not use any flux or grease.
- A diagonal cutter to trim excess wires. To avoid injury when cutting excess leads, hold the lead so they cannot fly towards the eyes.
- Needle nose pliers, for bending leads, or to hold components in place.
- Small blade and Phillips screwdrivers. A basic range is fine.

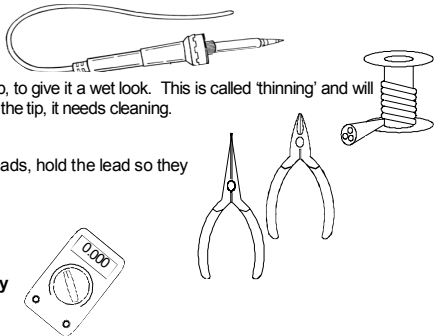

For some projects, a basic multi-meter is required, or might be handy

1.2 Assembly Hints :

- ⇒ Make sure the skill level matches your experience, to avoid disappointments.
 - ⇒ Follow the instructions carefully. Read and understand the entire step before you perform each operation.
 - ⇒ Perform the assembly in the correct order as stated in this manual
 - ⇒ Position all parts on the PCB (Printed Circuit Board) as shown on the drawings.
 - ⇒ Values on the circuit diagram are subject to changes.
 - ⇒ Values in this assembly guide are correct*
 - ⇒ Use the check-boxes to mark your progress.
 - ⇒ Please read the included information on safety and customer service
- * Typographical inaccuracies excluded. Always look for possible last minute manual updates, indicated as 'NOTE' on a separate leaflet.

1.3 Soldering Hints :

1- Mount the component against the PCB surface and carefully solder the leads

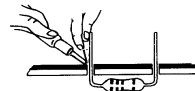

2- Make sure the solder joints are cone-shaped and shiny

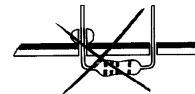
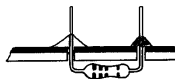

3- Trim excess leads as close as possible to the solder joint



REMOVE THEM FROM THE TAPE ONE AT A TIME !

**AXIAL COMPONENTS ARE TAPED IN THE
CORRECT MOUNTING SEQUENCE !**

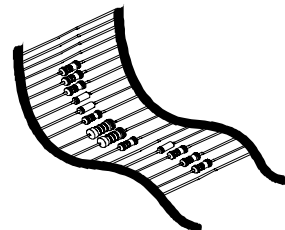

 You will find the colour code for the resistances and the LEDs on the product page on our website: www.velleman.eu

1. Diode. Watch the polarity !

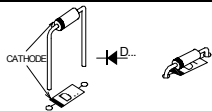

- D1 : 1N4148

2. Zener diode. Watch the polarity !

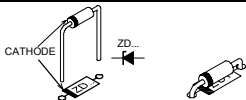

- ZD1 : 5V1 - 500mW

3. Diodes. Watch the polarity !

- D2 : 1N4007
- D3 : 1N4007
- D4 : 1N4007
- D5 : 1N4007

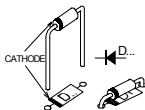

4. 1/4W Resistors

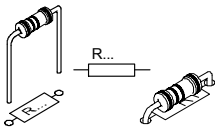

- R1 : 1K5 (1 - 5 - 2 - B)
- R2 : 1K5 (1 - 5 - 2 - B)
- R3 : 1K5 (1 - 5 - 2 - B)
- R4 : 10K (1 - 0 - 3 - B)
- R5 : 10K (1 - 0 - 3 - B)
- R6 : 10K (1 - 0 - 3 - B)
- R7 : 1K (1 - 0 - 2 - B)
- R8 : 10K (1 - 0 - 3 - B)

5. 1/2W Resistors

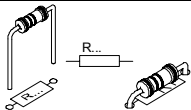

- R9 : 220 (2 - 2 - 1 - B - 9)
- R10 : 220 (2 - 2 - 1 - B - 9)

6. Push button.

- SW1 : KRS0611



7. IC socket. Watch the position of the notch!

- IC1 : 8p

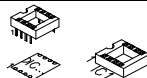

8. Capacitors

- C1 : 100nF (104)
- C2 : 100nF (104)



9. Dip Switch. (Watch the orientation)

- SW2 : DS-4

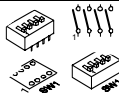

10. LED. Watch the polarity!

- LD1 : 3mm RED

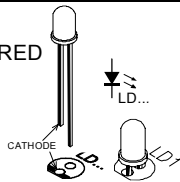
**11. Transistors.**

- T1 : BC547B
 T2 : BC547B

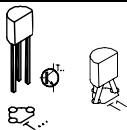
**12. Pin header**

- SK1

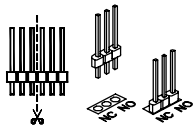
**13. Terminal blocks**

- SK2 : 2p
 SK3 : 2p

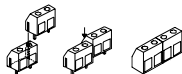

- SK4 : 3P

**14. Electrolytic Capacitors. Watch the polarity !**

- C3 : 100µF
 C4 : 100µF

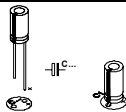
**15. Capacitors**

- C5 : 100nF / 250V

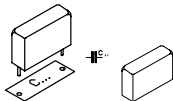
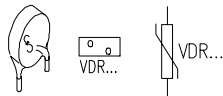
**16. VDR**

- VDR1 : VDR 300 VAC
 VDR2 : VDR 300 VAC

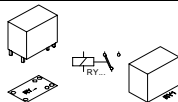
17. Relay

- RY1 : VR10V121C or eq.

18. IC. Watch the position of the notch!

- IC1 : VK8008

Programmed PIC12CE518

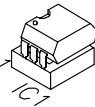

19. Shunt for transient suppressor.

The unit is equipped with a transient suppressor to reduce contact wear. With very small loads, it might be necessary to omit the shunt.



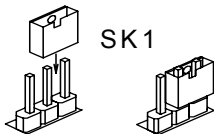

- Transient suppressor over the normal open contact

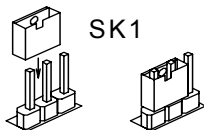







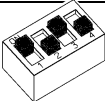
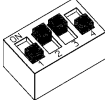
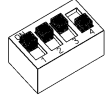

- Transient suppressor over the normal closed contact

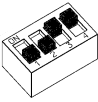

20. Operation mode

SW1	OPERATION MODE	DESCRIPTION
	Momentary mode	The load will be switched on as long as the pushbutton is pressed. Applications : doorbell, ...
	Toggle mode	Push once to turn on, push again to turn off the load. Applications : put a virtually unlimited number of pushbuttons in parallel to control a light source or other device.
	Start/stop timer	Push to turn on. After pre-set time has elapsed, load will turn off. Push any time to turn off. Load will turn off when pushbutton is held down and time elapses. Applications : General timing. Hint : use as 'Toggle mode' with a very long delay time. This will ensure lights will not remain on forever if forgotten to turn them off.
	Staircase timer	Push to turn on. After pre-set time has elapsed, load will turn off. A push during on-time will restart timer and stretch on-time. Applications : staircases, basements, storage rooms, front door lighting, ...
	Dual-time staircase timer	A short push turns on with delay1* while a longer push turns on with delay2*. Repeated short/long pushing during on-time will retrigger timer accordingly. Load will turn off when time elapses even when pushbutton is held down. Applications : same as above, but allows to select a longer time if necessary.

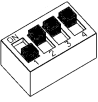
	<p>Non-retriggerable timer</p>	<p>Push to turn on. After pre-set time has elapsed, load will turn off. Pushing the button during on-time has no effect. Load will turn off when pushbutton is held down and time elapses. Applications : General timing.</p>
	<p>Turn-on delay</p>	<p>Turn on delay starts when button is pushed. When time elapses, load is turned on until button is released. Applications : Prevent cycling of light sources operated by a motion detector on porches, front doors, driveways, ...</p>
	<p>Timer with early re-trigger prevention</p>	<p>turn on with delay1*. When time elapses, load is turned off and delay2* is enabled. Load cannot be turned on again before delay2 elapses. Continuous pushing will not switch on the load when delay2 elapses. Applications : Prohibit continuous operation of heating, airc, TV, spa, ...</p>
	<p>Turn-off delay</p>	<p>Push to turn on load. When button is released, timer is started. When time elapses, load is turned off. Repeated push during on-time restarts timer. Applications : Allow a pump or fan to remain on for a while after a sensor detects pre-set level, to prevent cycling.</p>
	<p>Interval timer</p>	<p>As long as the button is pushed, the load will be turned on during delay1*, and turned off during delay2* Applications : Lawn sprinklers, pool pumps, compressor dehydration, ventilation, defrosting,</p>
	<p>Blinking circuit</p>	<p>As long as the button is pushed, the load is turned on and off with a fixed frequency of 1Hz. Applications : warning lights, buzzers, ...</p>

	Blinking circuit with timer	<p>Push to start the blinking action as described above. At release, the timer will start. When time elapses, the load is turned off. A push during on-time restarts the timer.</p> <p>Applications : warning lights, buzzers, ...</p>
	Random timer	<p>As long as the button is closed, the system will activate the output in a random manner (9 minutes to 2.5h between every transition). Initial load status at activation is also determined at random.</p> <p>Applications : Simulate presence at home during absence</p>
	Trigger-at-release timer	<p>The load will be turned on when the pushbutton is released. At release, the timer is started. When time elapses, output is turned off. Pushing again during on-time will restart the timer at release of the button.</p> <p>Applications : Ventilation of restrooms, restroom flush control, ...</p>
	Interruptible Real Time staircase timer	<p>Press briefly to activate interval 1, a prolonged push will activate interval 2. The charge will be neutralised after the interval, even if the button remains pressed down. Pressing the button briefly while the charge is activated will immediately neutralise this charge.</p> <p>applications : staircase light control, attics, basements, stores and warehouses</p>
	Learning mode	<p>(*) The learning mode allows you to fix the duration of delay1 and delay2. See further for instructions on how to use this mode.</p>

21. Learning mode

The learning mode allows you to store two different delays, each from 2s up to 12 days. The delays are called delay1 and delay2. Originally, delay1 has been factory set to 3 minutes, while delay2 has been set to 30 minutes. All timer modes use delay1, unless the mode uses both delays. You can change these delays to suit your needs. The new delays are stored in EEPROM, and will be kept in case of a power failure. To change the default delays, flip all dipswitches SW1 to the ON-position.

First, you store delay1:

Push the button once. (The load blinks once and turns on).

The recording starts.

Wait until the desired time has elapsed.

Push the button again, to stop recording (The load is turned off and the recording stops).

The load will blink once

To confirm the recorded time, press the button briefly within 5 seconds after stopping the recording.

The load will blink once to confirm the recorded time

Then you can store delay2:

Push the button once

The load blinks twice and turns on.

The recording starts.

Wait until the desired time has elapsed.

Push the button again, to stop recording.

The load will blink twice

To confirm the recorded time, press the button briefly within 5 seconds after stopping the recording

The load will blink twice to confirm the recorded time

Hint : Should you wish to change delay2, without changing delay1, simply enter a short 'dummy' time for delay1, without confirming it. Then you can proceed with delay2.

22. Connection example Low Voltage

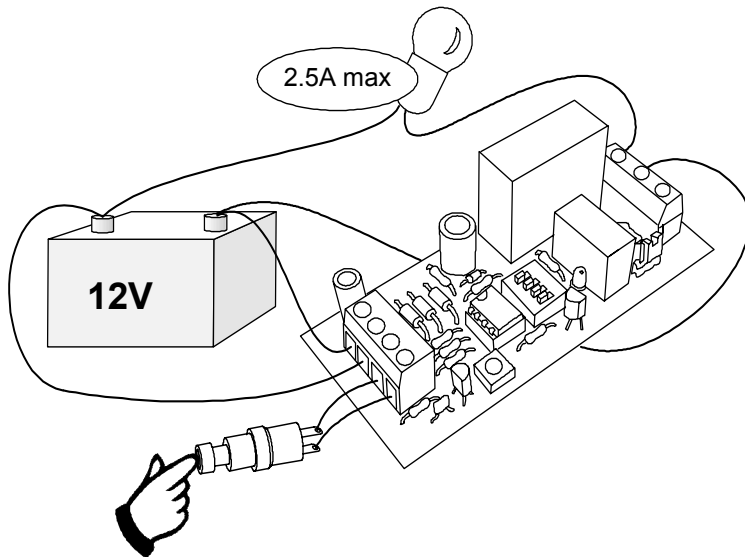

23. Connection example Mains Voltage

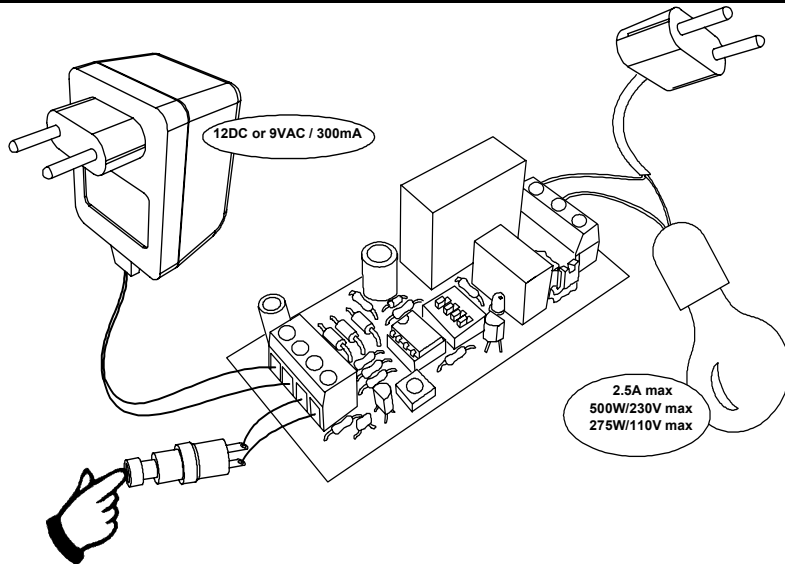

24. PCB

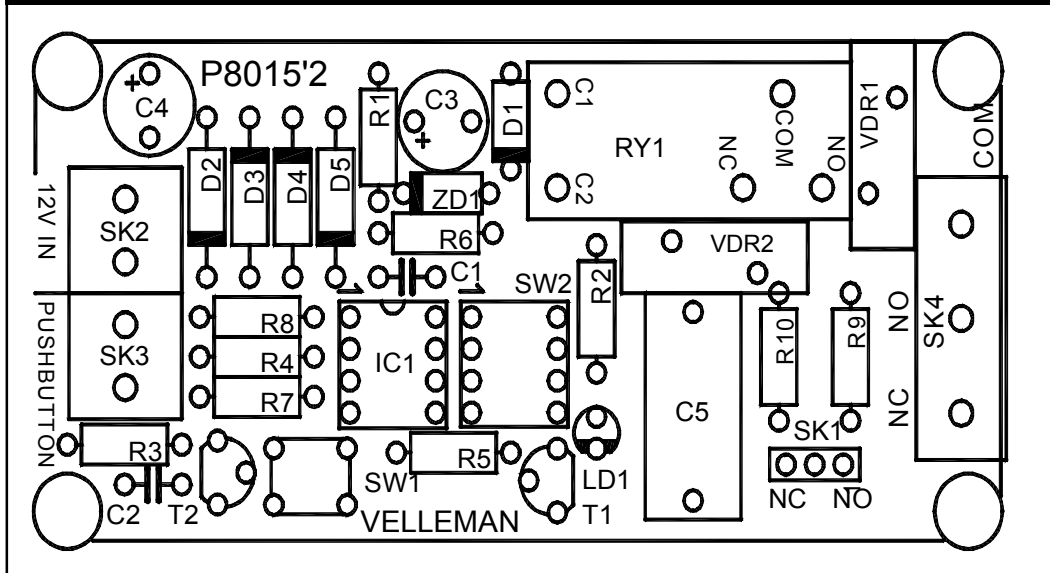

25. Diagram

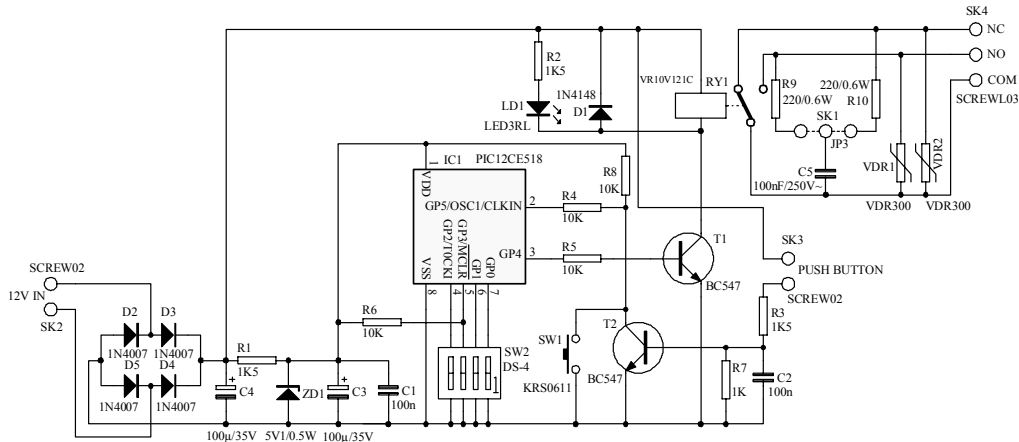

VELBUS
Velleman Home Automation System

**All appliances get intelligent, how about your home?
see our website : www.velbus.be**

Modifications and typographical errors reserved
 © Velleman nv.
 H8015IP - 2004 - ED2 (rev. 2.0)

VELLEMAN NV
Legen Heirweg 33, 9890 Gavere
Belgium - Europe

