

Total solder points: 126

Difficulty level: *beginner* 1 2 3 4 5 *advanced*

POWER DIMMER (1KW @ 230V)

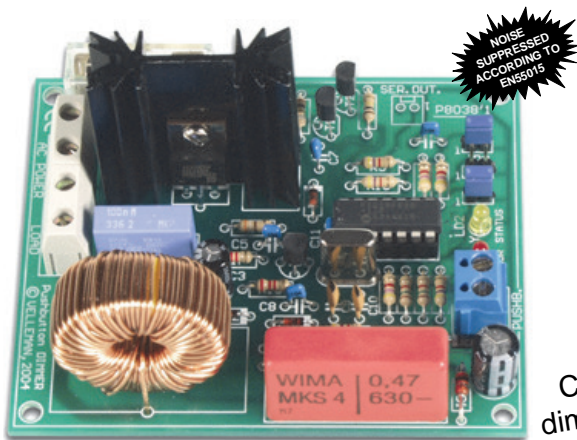

K8038

Class microcontroller high power dimmer with non volatile memory for last set light intensity.

Specifications:

- ☑ Class microcontroller high power dimmer, suitable for incandescent lamps, mains voltage halogen lighting and low voltage halogen lighting in combination with a conventional (wire wound) transformer.
- ☑ Easy pushbutton operation for dimming of light sources.
- ☑ Phase control can be disabled.
- ☑ Non volatile memory for last set light intensity.
- ☑ Lots of safety features to make lamps last as long as possible, such as “Softstart” and automatic turn-off after 12h or after 20min at too low intensity.
- ☑ Transformer protection in case of defective light sources.
- ☑ LED status indication.

Features:

- Suppression of radio & TV interference according to EN55015.
- Operating voltages: 110-125V or 220-240V AC (50/60Hz)
- Max. load: 1000W/230V or 500W/115V (5A)
- Max. phase shift with inductive load: 30°.
- Dimming speed: +/- 5 sec.
- PCB dimensions: 90 x 75 x 40 mm.



It is not recommended to use this dimmer with electronic transformers !!!

1. Assembly (Skipping this can lead to troubles !)

Ok, so we have your attention. These hints will help you to make this project successful. Read them carefully.

1.1 Make sure you have the right tools:

- A good quality soldering iron (25-40W) with a small tip.
- Wipe it often on a wet sponge or cloth, to keep it clean; then apply solder to the tip, to give it a wet look. This is called 'thinning' and will protect the tip, and enables you to make good connections. When solder rolls off the tip, it needs cleaning.
- Thin raisin-core solder. Do not use any flux or grease.
- A diagonal cutter to trim excess wires. To avoid injury when cutting excess leads, hold the lead so they cannot fly towards the eyes.
- Needle nose pliers, for bending leads, or to hold components in place.
- Small blade and Phillips screwdrivers. A basic range is fine.

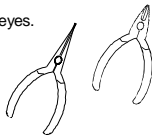

For some projects, a basic multi-meter is required, or might be handy

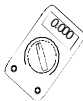

1.2 Assembly Hints :

- ⇒ Make sure the skill level matches your experience, to avoid disappointments.
- ⇒ Follow the instructions carefully. Read and understand the entire step before you perform each operation.
- ⇒ Perform the assembly in the correct order as stated in this manual
- ⇒ Position all parts on the PCB (Printed Circuit Board) as shown on the drawings.
- ⇒ Values on the circuit diagram are subject to changes, the values in this assembly guide are correct*
- ⇒ Use the check-boxes to mark your progress.
- ⇒ Please read the included information on safety and customer service

* Typographical inaccuracies excluded. Always look for possible last minute manual updates, indicated as 'NOTE' on a separate leaflet.

1.3 Soldering Hints :

1- Mount the component against the PCB surface and carefully solder the leads



2- Make sure the solder joints are cone-shaped and shiny



3- Trim excess leads as close as possible to the solder joint



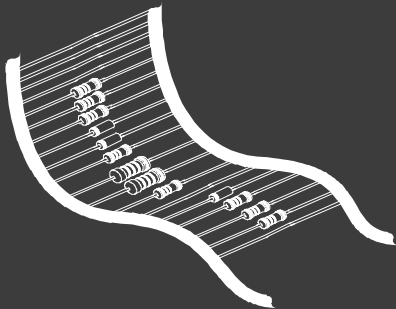

REMOVE THEM FROM THE TAPE ONE AT A TIME !

Included In
this kit

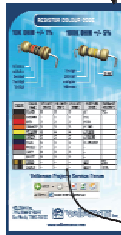

2. RESISTOR

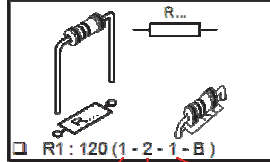

COLOUR	COLOUR NAME	1ST DIGIT/ STRIPE	2ND DIGIT/ STRIPE	3RD DIGIT/ STRIPE	MULTIPLIER STRIPE	TOL 4TH:
Black	BLACK	0	0	0	x1	1%
Brown	BROWN	1	1	1	x10	
Red	RED	2	2	2	x100	
Orange	ORANGE	3	3	3	x1.000	
Yellow	YELLOW	4	4	4	x10.000	
Green	GREEN	5	5	5	x100.000	
Blue	BLUE	6	6	6	x1.000.000	

**DO NOT BLINDLY FOLLOW THE ORDER OF THE COMPONENTS ONTO THE TAPE.
ALWAYS CHECK THEIR VALUE ON THE PARTS LIST!**

1. Diodes. Watch the polarity !

- D1 : 1N4148
- D2 : 1N4148
- D3 : 1N4007

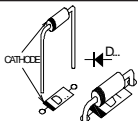

2. Zenerdiodes. Watch the polarity !

- ZD1 : 12V0
- ZD2 : 5V6
- ZD3 : 5V1
- ZD4 : 5V1

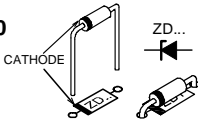

3. Metal film resistors

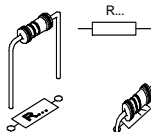

- R1 : 1M (1-0-5-B-9)
- R2 : 220E (2-2-1-B-9)
- R8 : 100K (1-0-4-B-9)

- R13 : 470K (4-7-4-B-9)
- R14 : 100K (1-0-4-B-9)
- R15 : 470K (4-7-4-B-9)

4. Resistors

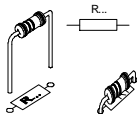

- R3 : 4K7 (4-7-2-B)
- R4 : 4K7 (4-7-2-B)
- R5 : 1K5 (1-5-2-B)
- R6 : 1K5 (1-5-2-B)
- R7 : 4K7 (4-7-2-B)
- R9 : 4K7 (4-7-2-B)
- R10 : 4K7 (4-7-2-B)
- R11 : 4K7 (4-7-2-B)
- R12 : 4K7 (4-7-2-B)
- R16 : 68 (6-8-0-B)
- R17 : 2K2 (2-2-2-B)
- R18 : 2K2 (2-2-2-B)

5. IC - socket. Watch the polarity !

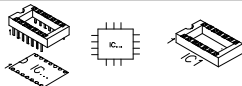

- IC1 : 14p

6. Capacitors.

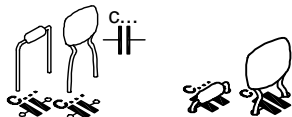

- C4 : 100nF (104)
- C5 : 10nF (103)
- C6 : 10nF (103)
- C7 : 10nF (103)
- C8 : 100nF (104)
- C9 : 15pF (15)
- C10 : 15pF (15)
- C11 : 100nF (104)

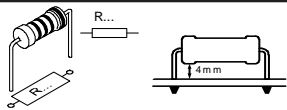
7. 1W resistor.

- R19 : 220 (2 - 2 - 1 - B)

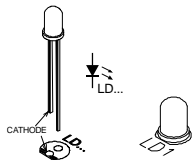
8. LEDs. Watch the polarity!

- LD1 : Red (Error)
 LD2 : Yellow (Status)

9. Transistors.

- T1 : BC547B
 T2 : BC547B
 T3 : BC547B

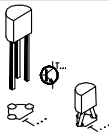
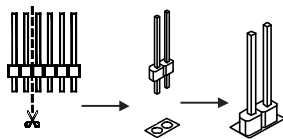
**10. Pin headers**

- JP1 : 2 pins
 JP2 : 2 pins
 JP3 : 2 pins

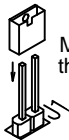

Mount the 3 shunts ; for their use: see pag. 9 - 10.

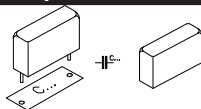
11. Capacitor

- C12 : 100nF/275VAC

12. Electrolytic Capacitors. Watch the polarity !

- C2 : 220 μ F
 C3 : 100 μ F

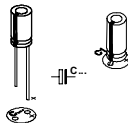
**13. Quartz crystal**

- X1 : 10MHz

14. Terminal blocks

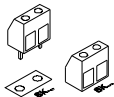

- SK3 (pushbutton)

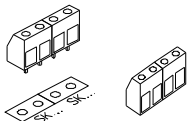

- SK1 (AC POWER)
- SK2 (LOAD)

15. Fuse + fuse holder

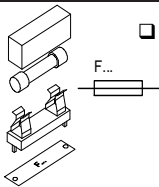

- F1 : 5A slow

16. Capacitor

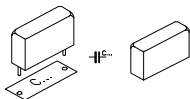

Choose operating voltage :

For 110 - 125VAC :

- C1 : 1 μ F / 250V

For 220 - 240VAC :

- C1 : 0,47 μ F / 600V

17. Triac

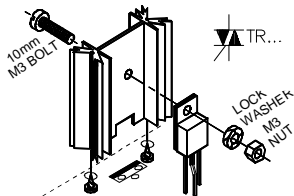

- TR1 : TIC226M

18. Coil.

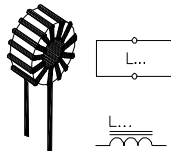

- L1 : 1mH / 5A

19. IC, Check the position of the notch!

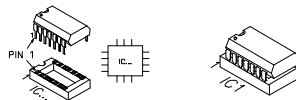

- IC1 : VK8038
programmed PIC16F630 - I/P

20. Connection

1. Connect the K8038 according to the wiring diagram.

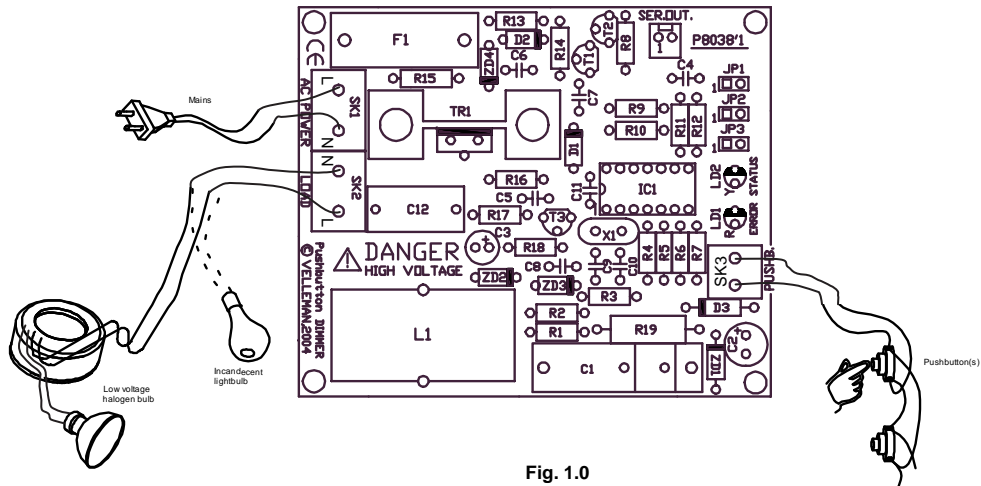

Fig. 1.0

2. Mount the jumpers on JP1,2,3 or leave them out according to the functions that have to be available.

JP1 Enable memory function

JP2 Disable phase control

JP3 Protection timers on

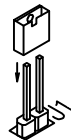

Fig. 2.0

JP1 – Memory function:

The last used brightness setting is memorized if this function is activated.

Removed: Memory function is deactivated.

or

Installed: Memory function is activated.

JP2 – Phase control:

Phase control is needed to control an inductive charge, such as a transformer. The phase control makes sure the triac is activated at the right moment in case of a current lag to the tension (phase shift). The phase control may only be disabled when a resistive charge is controlled and the lamp 'flashes' or when the K8038 should go into an unwarranted alarm condition. The phase control must NOT be disabled when controlling an inductive charge – this may cause serious damage to the K0838 and/or the used transformer.

Removed: Phase control is enabled. (default setting for normal use)

or

Installed: Phase control is disabled.

JP3 – Security Timers:

When this function is enabled, lamps are automatically switched off:

- ✔ after approx. 12 hours of uninterrupted operation.
- ✔ after 20min when the lamp brightness is too low – this will shorten its life span.

Removed: Security timers are disabled.
or

Installed: Security timers are enabled.

3. Connect a charge that is compatible with this module!

If the controlled power exceeds 500W (250W @ 110V), the housing has to be equipped with forced cooling (fan).

21. USE

Switch the mains tension on.

When K8038 is switched on, LD1 & LD2 will light up for a brief moment during the diagnosis test. LD1 will flash 10x if the phase control function is disabled (JP2 in place). Afterwards, LD2 flashes once for a 50Hz mains frequency or twice for 60Hz. The dimmer is now operational.

Press the control button briefly to activate or deactivate the power point or keep the button pressed to adjust the brightness.

LED INDICATIONS DURING NORMAL OPERATION :

LD1 (red LED):

- Flashes slowly together with LD2 (yellow LED) when the brightness is too low – this can only happen when jumper JP3 is in place.

LD2 (yellow LED):

- Flashes once every 5 seconds when the module is not in use (lamp out).
- Flashes slowly (2x/sec) when the lamp is on but not at full force.
- Keeps on burning when the lighting is at full force.
- Flashes very rapidly (10x/sec) during changes in brightness.

LED INDICATIONS DURING FAULT REPORT :

When the CPU detects an error, LD1 (red) can give us an indication on the nature of the problem. LD2 (yellow) will then burn continuously while LD1 (red) will repeatedly flash a number of times.

We suggest interrupting the mains tension for a moment and evaluating the situation.

The K8038 can be restarted without switching the tension off: keep the control button pressed until both LEDs go out (approx. 10 seconds).

Flashes LD1	Error	Possible cause / solution
1	Time-out in the positive alternance of the mains tension	Error in the voltage zero crossing circuit (T1, ...)
2	Time-out in de negative alternance of the mains tension	Error in the voltage zero crossing circuit (T1, ...)
3	Time-out triac control	<ul style="list-style-type: none"> - Faulty triac? - Faulty power point? - T2 defect? - Charge does not comply with specifications?
4	Phase shift too big	<ul style="list-style-type: none"> - Charge behaves too inductively? - No charge connected? - Transformer uncharged (by faulty lamp)? - Not-compatible charge?

SETTING MINIMUM BRIGHTNESS:

- Keep the control button pressed until both LEDs light up (after about 3 seconds) while powering on the K8038.
- The lamp will now burn at her present minimum brightness
- Change the brightness by pressing the pushbutton briefly and repeatedly (10 steps are available).
- Interrupt the power supply briefly when the desired setting has been obtained.
- Now start the K8038 normally.

The "SER OUT" connector on the print is only used for diagnosis and repair purposes on this kit by the members of our technical department.

22. PCB layout.

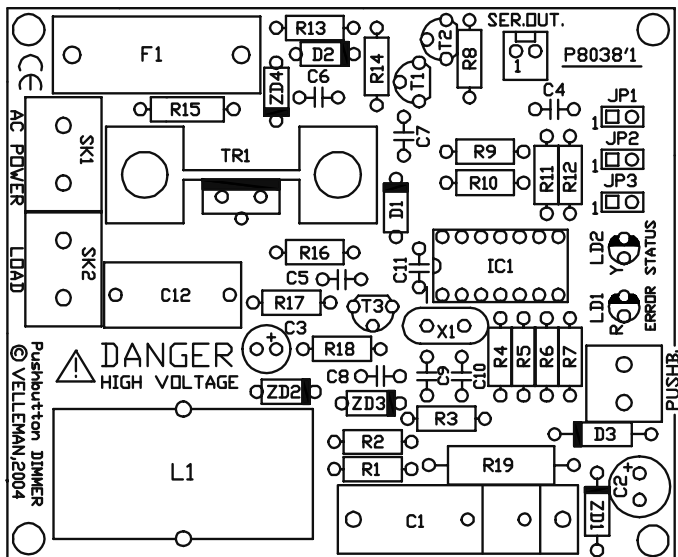

23. Diagram

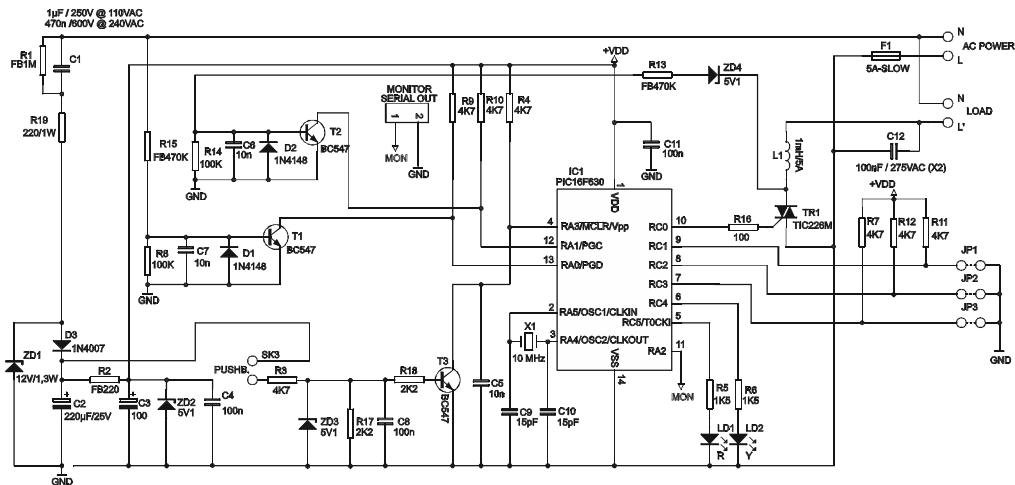

EDU 01**SOLDERLESS EDUCATIVE STARTERBOX**

The EDU01 basic experiment kit is the first step into the world of modern electronics. Build your own circuits in a fun, safe and educative way.

AVAILABLE**EDU 02****SOLAR ENERGY EXPERIMENT KIT**

Fun solar powered projects. Learn all about solar energy.

AVAILABLE**EDU 03****SOLDER EDUCATIVE STARTER BOX**

Learn how to solder, build different exciting projects. Includes spare components and demo boards.

COMING SOON**EDU 04****PIC™ TUTOR KIT**

Enter the world of microcontroller programming, easy step by step instructions. Includes programmer and test board.

COMING SOON**EDU 05****USB TUTOR BOARD**

Learn how to connect your computer with the outside world, master the USB communication with tutorial examples. Play with LED indicators and learn how to drive LCD displays.

COMING SOON**EDU 06****SCOPE EDUKIT**

This board with different signals will teach you how to use an oscilloscope. Optimized instructions for use of our HPS140 oscilloscope. YouTube demo movies.

COMING SOON