

Total solder points: 63
Difficulty level: *beginner* 1 2 3 4 5 *advanced*

velleman[®]-**kit** HIGH-Q

2 CHANNEL RF CODELOCK TRANSMITTER



K8059

For use with K8057/VM109
2 Channel RF receiver



Features:

- ☑ For use with the K8057/VM109 2-channel RF receivers.
- ☑ Generates unique 32-bit code.
- ☑ More than 1,000,000,000 unique codes.
- ☑ Code can easily be changed for safety purposes.
- ☑ Choose continuous or 'burst' transmission.
- ☑ LED indicator.
- ☑ Limited compatibility with K6706 - K6706A - K6706B/G

Specifications:

- Power supply: 12V battery V23GA, GP23GA,... (not incl.)
- 433MHz operation
- Open field range of up to 30m possible
- Dimensions: 63 x 40 x 16mm (2.5" x 1.6" x 0.6")

Velleman hereby certifies that the device K8059 meets the essential requirements and all other relevant stipulations of directive 1999/5/EG and 1995/5/EC.

For the complete conformity declaration check out :
http://www.velleman.be/downloads/doc/ce_k8059.pdf

1. Assembly (Skipping this can lead to troubles !)

Ok, so we have your attention. These hints will help you to make this project successful. Read them carefully.

1.1 Make sure you have the right tools:

- A good quality soldering iron (25-40W) with a small tip.
- Wipe it often on a wet sponge or cloth, to keep it clean; then apply solder to the tip, to give it a wet look. This is called 'thinning' and will protect the tip, and enables you to make good connections. When solder rolls off the tip, it needs cleaning.
- Thin raisin-core solder. Do not use any flux or grease.
- A diagonal cutter to trim excess wires. To avoid injury when cutting excess leads, hold the lead so they cannot fly towards the eyes.
- Needle nose pliers, for bending leads, or to hold components in place.
- Small blade and Phillips screwdrivers. A basic range is fine.

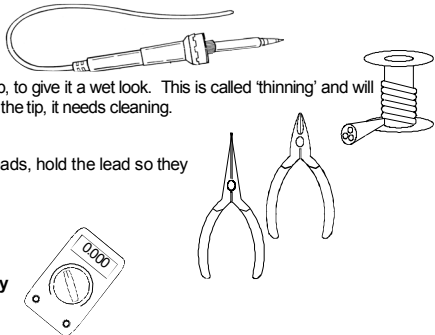

For some projects, a basic multi-meter is required, or might be handy

1.2 Assembly Hints :

- ⇒ Make sure the skill level matches your experience, to avoid disappointments.
 - ⇒ Follow the instructions carefully. Read and understand the entire step before you perform each operation.
 - ⇒ Perform the assembly in the correct order as stated in this manual
 - ⇒ Position all parts on the PCB (Printed Circuit Board) as shown on the drawings.
 - ⇒ Values on the circuit diagram are subject to changes.
 - ⇒ Values in this assembly guide are correct*
 - ⇒ Use the check-boxes to mark your progress.
 - ⇒ Please read the included information on safety and customer service
- * Typographical inaccuracies excluded. Always look for possible last minute manual updates, indicated as 'NOTE' on a separate leaflet.

1.3 Soldering Hints :

1- Mount the component against the PCB surface and carefully solder the leads

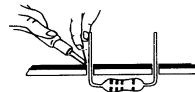

2- Make sure the solder joints are cone-shaped and shiny

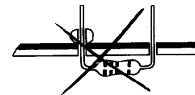
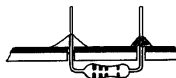

3- Trim excess leads as close as possible to the solder joint

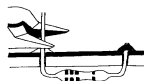

REMOVE THEM FROM THE TAPE ONE AT A TIME !

**AXIAL COMPONENTS ARE TAPED IN THE
CORRECT MOUNTING SEQUENCE !**

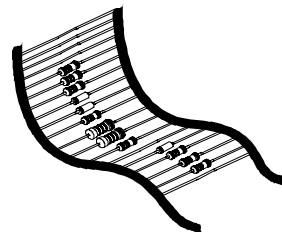

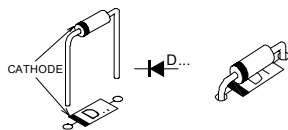
1. Diodes. Watch the polarity!

- D1 : BAT85
- D2 : BAT85

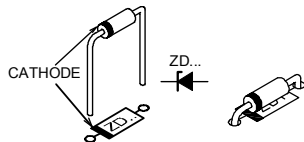
2. Zenerdiode. Watch the polarity!

- ZD1 : 5V1 / 500mW

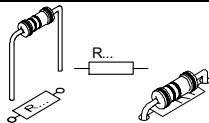
3. 1/8W Resistors

- R1 : 33K (3 - 3 - 3 - B)
- R2 : 33K (3 - 3 - 3 - B)
- R3 : 33K (3 - 3 - 3 - B)
- R4 : 47 (4 - 7 - 0 - B)
- R5 : 220 (2 - 2 - 1 - B)
- R6 : 2K7 (2 - 7 - 2 - B)

4. SAW resonator

- X1 : SAW433

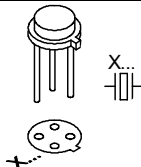
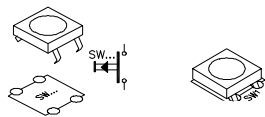
**5. Push buttons**

- SW1 : KRS0611
- SW2 : KRS0611
- SW3 : KRS0611

6. IC socket. Pay attention to the position of the notch!

- IC1 : 8p

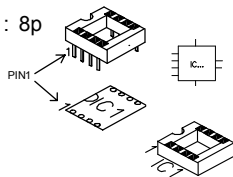

7. Battery contacts

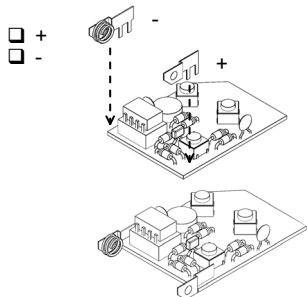

☞ Check for good attachment of the solder to the contacts

8. LED

☐ LD1 : 3mm blue

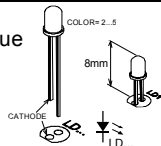

9. Capacitors

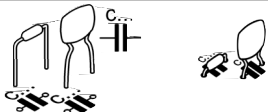

☐ C1 : 1pF (1)

☐ C2 : 4p7 (4.7)

☐ C3 : 100pF (101)

☞ Bend C3 away from the LED

☐ C4 : 100pF (101)

☐ C5 : 100pF (101)

☐ C6 : 100nF (104)

10. Transistor

☐ T1 : MPSH10

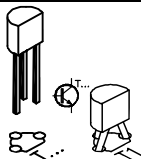

11. IC. Pay attention to the notch !

☐ IC1 : VK8059

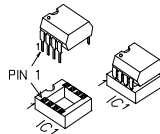

VK8059=(Programmed PIC12F629)

☞ Pay attention to the position of the notch!

12. Sticker

Affix the supplied sticker to the back of the housing.



13. Use

The transmitter comes with a factory set default code. However, for security reasons, it might be wise not to use the default code.

1. To program your unique code :

- Hold SW 1(*) (left button).
- Briefly press the 'program'-button (SW3) 3 times. The LED will flash 3 times.
- Release SW 1.
- Your unique 32-bit code has been generated and stored.

(*If you hold SW2 (right button) instead of SW 1 (left button), the unit will generate and store your unique 32-bit code and the transmitter will be configured in such a way that continuous transmission is not possible i.e. if you hold either button transmission will stop after a +/- 1s)

2. To return to the default code :

- Hold SW 1 (left button).
- Hold the 'program'-button (SW3).
- After +/- 10s the led will flash 5 times.
- Release both buttons.
- Your code has been erased.



To set a new code, see point 1.

3. Compatibility with previous transmitters (K6706 - K6706A - K6706B - K6706G) :

3 different codes can be generated, solder a bridge as indicated below.

MODIFY EXCISTING TRANSMITTERS AND RECEIVERS :

NEW

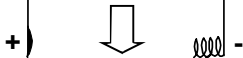
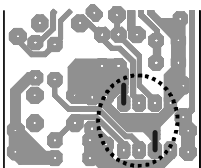

UM3758
No code

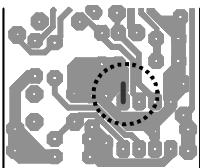

UM3758
Pin1 with -

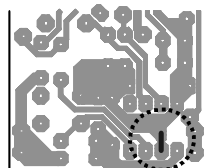

UM3758
Pin1 with +

OLD

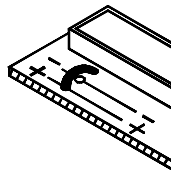
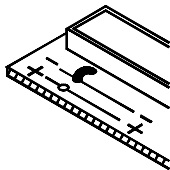
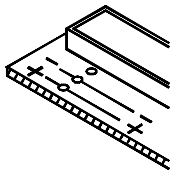

14. Schematic diagram.

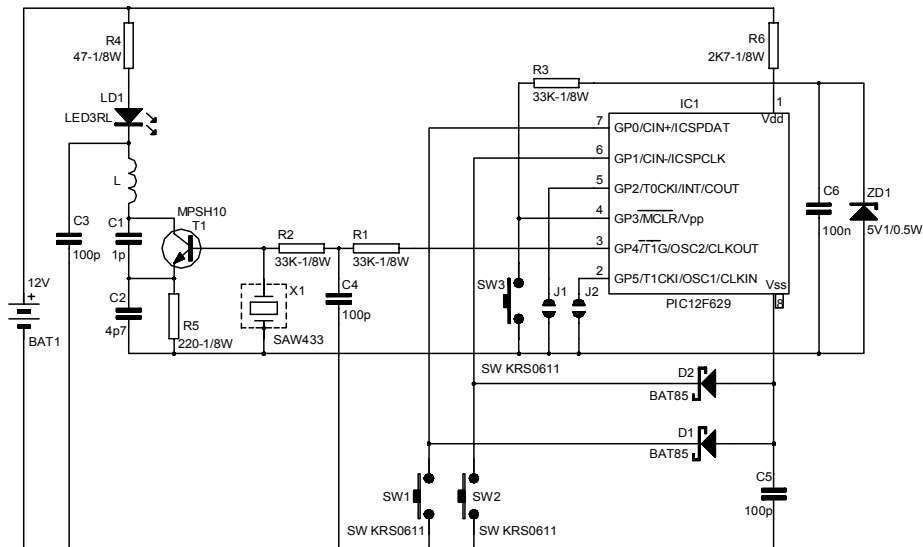

15. PCB

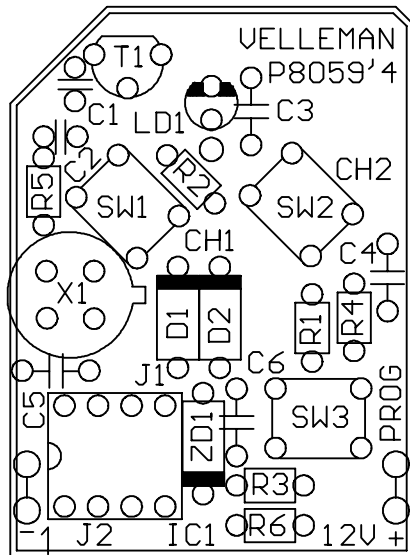

DOMOTIC SYSTEM



intento © bygen-licenze

VELBUS.EU

