

# LMC6482 CMOS Dual Rail-To-Rail Input and Output Operational Amplifier

## General Description

The LMC6482 provides a common-mode range that extends to both supply rails. This rail-to-rail performance combined with excellent accuracy, due to a high CMRR, makes it unique among rail-to-rail input amplifiers.

It is ideal for systems, such as data acquisition, that require a large input signal range. The LMC6482 is also an excellent upgrade for circuits using limited common-mode range amplifiers such as the TLC272 and TLC277.

Maximum dynamic signal range is assured in low voltage and single supply systems by the LMC6482's rail-to-rail output swing. The LMC6482's rail-to-rail output swing is guaranteed for loads down to 600Ω.

Guaranteed low voltage characteristics and low power dissipation make the LMC6482 especially well-suited for battery-operated systems.

LMC6482 is also available in MSOP package which is almost half the size of a SO-8 device.

See the LMC6484 data sheet for a Quad CMOS operational amplifier with these same features.

## Features

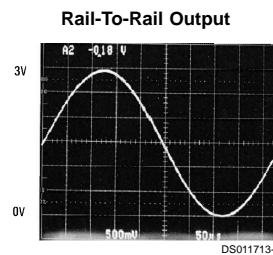
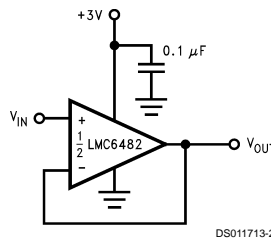
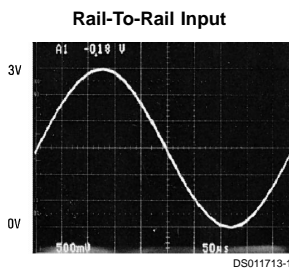
(Typical unless otherwise noted)

- Rail-to-Rail Input Common-Mode Voltage Range (Guaranteed Over Temperature)
- Rail-to-Rail Output Swing (within 20 mV of supply rail, 100 kΩ load)
- Guaranteed 3V, 5V and 15V Performance
- Excellent CMRR and PSRR: 82 dB
- Ultra Low Input Current: 20 fA
- High Voltage Gain ( $R_L = 500 \text{ k}\Omega$ ): 130 dB
- Specified for 2 kΩ and 600Ω loads
- Available in MSOP Package

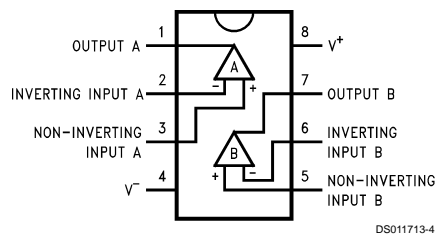
## Applications

- Data Acquisition Systems
- Transducer Amplifiers
- Hand-held Analytic Instruments
- Medical Instrumentation
- Active Filter, Peak Detector, Sample and Hold, pH Meter, Current Source
- Improved Replacement for TLC272, TLC277

## 3V Single Supply Buffer Circuit



## Connection Diagram



## Ordering Information

Package	Temperature Range		NSC Drawing	Transport Media	Package Marking
	Military -55°C to +125°C	Industrial -40°C to +85°C			
8-Pin Molded DIP	LMC6482MN	LMC6482AIN, LMC6482IN	N08E	Rail	LMC6482MN, LMC6482AIN, LMC6482IN
8-pin Small Outline		LMC6482AIM, LMC6482IM	M08A	Rail Tape and Reel	LMC6482AIM, LMC6482IM
8-pin Ceramic DIP	LMC6482AMJ/883		J08A	Rail	LMC6482AMJ/883Q5962-9453401MPA
8-pin Mini SO		LMC6482IMM	MUA08A	Rail Tape and Reel	A10

## Absolute Maximum Ratings (Note 1)

If Military/Aerospace specified devices are required, please contact the National Semiconductor Sales Office/Distributors for availability and specifications.

ESD Tolerance (Note 2)	1.5 kV
Differential Input Voltage	±Supply Voltage
Voltage at Input/Output Pin	(V <sup>+</sup> ) +0.3V, (V <sup>-</sup> ) -0.3V
Supply Voltage (V <sup>+</sup> - V <sup>-</sup> )	16V
Current at Input Pin (Note 12)	±5 mA
Current at Output Pin (Notes 3, 8)	±30 mA
Current at Power Supply Pin	40 mA
Lead Temperature (Soldering, 10 sec.)	260°C

Storage Temperature Range	-65°C to +150°C
Junction Temperature (Note 4)	150°C

## Operating Ratings (Note 1)

Supply Voltage	3.0V ≤ V <sub>+</sub> ≤ 15.5V
Junction Temperature Range	
LMC6482AM	-55°C ≤ T <sub>J</sub> ≤ +125°C
LMC6482AI, LMC6482I	-40°C ≤ T <sub>J</sub> ≤ +85°C
Thermal Resistance (θ <sub>JA</sub> )	
N Package, 8-Pin Molded DIP	90°C/W
M Package, 8-Pin Surface Mount	155°C/W
MSOP package, 8-Pin Mini SO	194°C/W

## DC Electrical Characteristics

Unless otherwise specified, all limits guaranteed for T<sub>J</sub> = 25°C, V<sup>+</sup> = 5V, V<sup>-</sup> = 0V, V<sub>CM</sub> = V<sub>O</sub> = V<sup>+</sup>/2 and R<sub>L</sub> > 1M. **Boldface** limits apply at the temperature extremes.

Symbol	Parameter	Conditions	Typ (Note 5)	LMC6482AI	LMC6482I	LMC6482M	Units	
				Limit (Note 6)	Limit (Note 6)	Limit (Note 6)		
V <sub>OS</sub>	Input Offset Voltage		0.11	0.750	3.0	3.0	mV	
				<b>1.35</b>	<b>3.7</b>	<b>3.8</b>	max	
TCV <sub>OS</sub>	Input Offset Voltage Average Drift		1.0				µV/°C	
I <sub>B</sub>	Input Current	(Note 13)	0.02	<b>4.0</b>	<b>4.0</b>	<b>10.0</b>	pA max	
I <sub>OS</sub>	Input Offset Current	(Note 13)	0.01	<b>2.0</b>	<b>2.0</b>	<b>5.0</b>	pA max	
C <sub>IN</sub>	Common-Mode Input Capacitance		3				pF	
R <sub>IN</sub>	Input Resistance		>10				TeraΩ	
CMRR	Common Mode Rejection Ratio	0V ≤ V <sub>CM</sub> ≤ 15.0V V <sup>+</sup> = 15V	82	70 <b>67</b>	65 <b>62</b>	65 <b>60</b>	dB min	
		0V ≤ V <sub>CM</sub> ≤ 5.0V V <sup>+</sup> = 5V	82	70 <b>67</b>	65 <b>62</b>	65 <b>60</b>		
+PSRR	Positive Power Supply Rejection Ratio	5V ≤ V <sup>+</sup> ≤ 15V, V <sup>-</sup> = 0V V <sub>O</sub> = 2.5V	82	70 <b>67</b>	65 <b>62</b>	65 <b>60</b>	dB min	
-PSRR	Negative Power Supply Rejection Ratio	-5V ≤ V <sup>-</sup> ≤ -15V, V <sup>+</sup> = 0V V <sub>O</sub> = -2.5V	82	70 <b>67</b>	65 <b>62</b>	65 <b>60</b>	dB min	
V <sub>CM</sub>	Input Common-Mode Voltage Range	V <sup>+</sup> = 5V and 15V For CMRR ≥ 50 dB	V <sup>-</sup> - 0.3	- 0.25 <b>0</b>	- 0.25 <b>0</b>	- 0.25 <b>0</b>	V max	
			V <sup>+</sup> + 0.3V	V <sup>+</sup> + 0.25 <b>V<sup>+</sup></b>	V <sup>+</sup> + 0.25 <b>V<sup>+</sup></b>	V <sup>+</sup> + 0.25 <b>V<sup>+</sup></b>	V min	
A <sub>V</sub>	Large Signal Voltage Gain	R <sub>L</sub> = 2 kΩ (Notes 7, 13)	Sourcing	666	140 <b>84</b>	120 <b>72</b>	120 <b>60</b>	V/mV min
			Sinking	75	35 <b>20</b>	35 <b>20</b>	35 <b>18</b>	V/mV min
		R <sub>L</sub> = 600Ω (Notes 7, 13)	Sourcing	300	80 <b>48</b>	50 <b>30</b>	50 <b>25</b>	V/mV min
			Sinking	35	20 <b>13</b>	15 <b>10</b>	15 <b>8</b>	V/mV min

## DC Electrical Characteristics (Continued)

Unless otherwise specified, all limits guaranteed for  $T_J = 25^\circ\text{C}$ ,  $V^+ = 5\text{V}$ ,  $V^- = 0\text{V}$ ,  $V_{\text{CM}} = V_O = V^+/2$  and  $R_L > 1\text{M}$ . **Boldface** limits apply at the temperature extremes.

Symbol	Parameter	Conditions	Typ (Note 5)	LMC6482AI Limit (Note 6)	LMC6482I Limit (Note 6)	LMC6482M Limit (Note 6)	Units	
$V_O$	Output Swing	$V^+ = 5\text{V}$ $R_L = 2\text{ k}\Omega$ to $V^+/2$	4.9	4.8	4.8	4.8	V	
			0.1	0.18	0.18	0.18	V min	
		$V^+ = 5\text{V}$ $R_L = 600\Omega$ to $V^+/2$	4.7	4.5	4.5	4.5	V	
			0.3	0.5	0.5	0.5	V min	
		$V^+ = 15\text{V}$ $R_L = 2\text{ k}\Omega$ to $V^+/2$	14.7	14.4	14.4	14.4	V	
			0.16	0.32	0.32	0.32	V min	
	$V^+ = 15\text{V}$ $R_L = 600\Omega$ to $V^+/2$	14.1	13.4	13.4	13.4	V		
		0.5	1.0	1.0	1.0	V min		
	$I_{\text{SC}}$	Output Short Circuit Current $V^+ = 5\text{V}$	Sourcing, $V_O = 0\text{V}$	20	16	16	16	mA
			Sinking, $V_O = 5\text{V}$	15	11	11	11	mA min
	$I_{\text{SC}}$	Output Short Circuit Current $V^+ = 15\text{V}$	Sourcing, $V_O = 0\text{V}$	30	28	28	28	mA
			Sinking, $V_O = 12\text{V}$ (Note 8)	30	30	30	30	mA min
$I_S$	Supply Current	Both Amplifiers $V^+ = +5\text{V}$ , $V_O = V^+/2$	1.0	1.4	1.4	1.4	mA	
		Both Amplifiers $V^+ = 15\text{V}$ , $V_O = V^+/2$	1.3	1.6	1.6	1.6	mA max	

## AC Electrical Characteristics

Unless otherwise specified, all limits guaranteed for  $T_J = 25^\circ\text{C}$ ,  $V^+ = 5\text{V}$ ,  $V^- = 0\text{V}$ ,  $V_{\text{CM}} = V_O = V^+/2$ , and  $R_L > 1\text{M}$ . **Boldface** limits apply at the temperature extremes.

Symbol	Parameter	Conditions	Typ (Note 5)	LMC6482AI Limit (Note 6)	LMC6482I Limit (Note 6)	LMC6482M Limit (Note 6)	Units
SR	Slew Rate	(Note 9)	1.3	1.0	0.9	0.9	V/ $\mu\text{s}$ min
GBW	Gain-Bandwidth Product	$V^+ = 15\text{V}$	1.5				MHz
$\phi_m$	Phase Margin		50				Deg
$G_m$	Gain Margin		15				dB
	Amp-to-Amp Isolation	(Note 10)	150				dB
$e_n$	Input-Referred Voltage Noise	$F = 1\text{ kHz}$ $V_{\text{cm}} = 1\text{V}$	37				nV/ $\sqrt{\text{Hz}}$
$i_n$	Input-Referred Current Noise	$F = 1\text{ kHz}$	0.03				pA/ $\sqrt{\text{Hz}}$

## AC Electrical Characteristics (Continued)

Unless otherwise specified, all limits guaranteed for  $T_J = 25^\circ\text{C}$ ,  $V^+ = 5\text{V}$ ,  $V^- = 0\text{V}$ ,  $V_{\text{CM}} = V_O = V^+/2$ , and  $R_L > 1\text{M}$ . **Boldface** limits apply at the temperature extremes.

Symbol	Parameter	Conditions	Typ (Note 5)	LMC6482AI Limit (Note 6)	LMC6482I Limit (Note 6)	LMC6482M Limit (Note 6)	Units
T.H.D.	Total Harmonic Distortion	$F = 10\text{ kHz}$ , $A_V = -2$ $R_L = 10\text{ k}\Omega$ , $V_O = 4.1\text{ V}_{\text{PP}}$	0.01				%
		$F = 10\text{ kHz}$ , $A_V = -2$ $R_L = 10\text{ k}\Omega$ , $V_O = 8.5\text{ V}_{\text{PP}}$ $V^+ = 10\text{V}$	0.01				%

## DC Electrical Characteristics

Unless otherwise specified, all limits guaranteed for  $T_J = 25^\circ\text{C}$ ,  $V^+ = 3\text{V}$ ,  $V^- = 0\text{V}$ ,  $V_{\text{CM}} = V_O = V^+/2$  and  $R_L > 1\text{M}$ .

Symbol	Parameter	Conditions	Typ (Note 5)	LMC6482AI Limit (Note 6)	LMC6482I Limit (Note 6)	LMC6482M Limit (Note 6)	Units
$V_{\text{OS}}$	Input Offset Voltage		0.9	2.0 <b>2.7</b>	3.0 <b>3.7</b>	3.0 <b>3.8</b>	mV max
$\text{TCV}_{\text{OS}}$	Input Offset Voltage Average Drift		2.0				$\mu\text{V}/^\circ\text{C}$
$I_B$	Input Bias Current		0.02				pA
$I_{\text{OS}}$	Input Offset Current		0.01				pA
CMRR	Common Mode Rejection Ratio	$0\text{V} \leq V_{\text{CM}} \leq 3\text{V}$	74	64	60	60	dB min
PSRR	Power Supply Rejection Ratio	$3\text{V} \leq V^+ \leq 15\text{V}$ , $V^- = 0\text{V}$	80	68	60	60	dB min
$V_{\text{CM}}$	Input Common-Mode Voltage Range	For CMRR $\geq 50\text{ dB}$	$V^- - 0.25$	0	0	0	V max
			$V^+ + 0.25$	$V^+$	$V^+$	$V^+$	V min
$V_O$	Output Swing	$R_L = 2\text{ k}\Omega$ to $V^+/2$	2.8				V
			0.2				V
		$R_L = 600\Omega$ to $V^+/2$	2.7	2.5	2.5	2.5	V min
			0.37	0.6	0.6	0.6	V max
$I_S$	Supply Current	Both Amplifiers	0.825	1.2 <b>1.5</b>	1.2 <b>1.5</b>	1.2 <b>1.6</b>	mA max

## AC Electrical Characteristics

Unless otherwise specified,  $V^+ = 3\text{V}$ ,  $V^- = 0\text{V}$ ,  $V_{\text{CM}} = V_O = V^+/2$ , and  $R_L > 1\text{M}$ .

Symbol	Parameter	Conditions	Typ (Note 5)	LMC6482AI Limit (Note 6)	LMC6482I Limit (Note 6)	LMC6482M Limit (Note 6)	Units
SR	Slew Rate	(Note 11)	0.9				V/ $\mu\text{s}$
GBW	Gain-Bandwidth Product		1.0				MHz
T.H.D.	Total Harmonic Distortion	$F = 10\text{ kHz}$ , $A_V = -2$ $R_L = 10\text{ k}\Omega$ , $V_O = 2\text{ V}_{\text{PP}}$	0.01				%

**Note 1:** Absolute Maximum Ratings indicate limits beyond which damage to the device may occur. Operating Ratings indicate conditions for which the device is intended to be functional, but specific performance is not guaranteed. For guaranteed specifications and the test conditions, see the Electrical Characteristics.

**Note 2:** Human body model, 1.5 k $\Omega$  in series with 100 pF. All pins rated per method 3015.6 of MIL-STD-883. This is a Class 1 device rating.

## AC Electrical Characteristics (Continued)

**Note 3:** Applies to both single-supply and split-supply operation. Continuous short circuit operation at elevated ambient temperature can result in exceeding the maximum allowed junction temperature of 150°C. Output currents in excess of ±30 mA over long term may adversely affect reliability.

**Note 4:** The maximum power dissipation is a function of  $T_{J(max)}$ ,  $\theta_{JA}$ , and  $T_A$ . The maximum allowable power dissipation at any ambient temperature is  $P_D = (T_{J(max)} - T_A)/\theta_{JA}$ . All numbers apply for packages soldered directly into a PC board.

**Note 5:** Typical Values represent the most likely parametric norm.

**Note 6:** All limits are guaranteed by testing or statistical analysis.

**Note 7:**  $V^+ = 15V$ ,  $V_{CM} = 7.5V$  and  $R_L$  connected to 7.5V. For Sourcing tests,  $7.5V \leq V_O \leq 11.5V$ . For Sinking tests,  $3.5V \leq V_O \leq 7.5V$ .

**Note 8:** Do not short circuit output to  $V^+$ , when  $V^+$  is greater than 13V or reliability will be adversely affected.

**Note 9:**  $V^+ = 15V$ . Connected as Voltage Follower with 10V step input. Number specified is the slower of either the positive or negative slew rates.

**Note 10:** Input referred,  $V^+ = 15V$  and  $R_L = 100 k\Omega$  connected to 7.5V. Each amp excited in turn with 1 kHz to produce  $V_O = 12 V_{pp}$ .

**Note 11:** Connected as voltage Follower with 2V step input. Number specified is the slower of either the positive or negative slew rates.

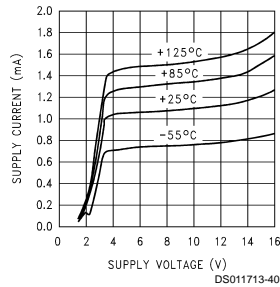
**Note 12:** Limiting input pin current is only necessary for input voltages that exceed absolute maximum input voltage ratings.

**Note 13:** Guaranteed limits are dictated by tester limitations and not device performance. Actual performance is reflected in the typical value.

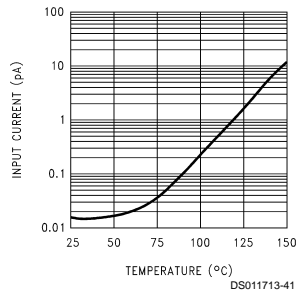
**Note 14:** For guaranteed Military Temperature parameters see RETS6482X.

## Typical Performance Characteristics $V_S = +15V$ , Single Supply, $T_A = 25^\circ C$ unless otherwise specified

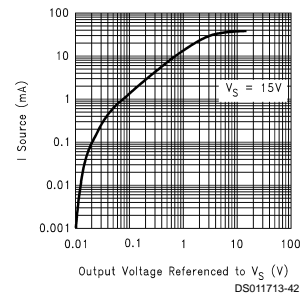
**Supply Current vs Supply Voltage**



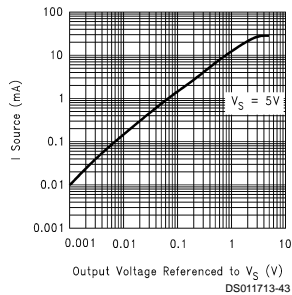
**Input Current vs Temperature**



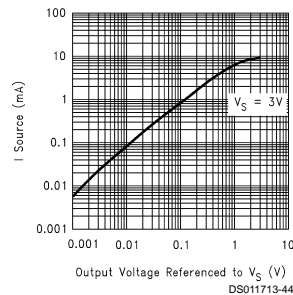
**Sourcing Current vs Output Voltage**



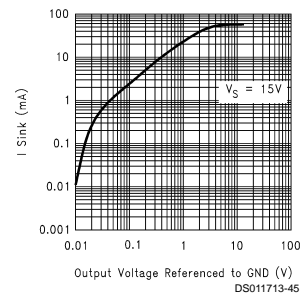
**Sourcing Current vs Output Voltage**



**Sourcing Current vs Output Voltage**

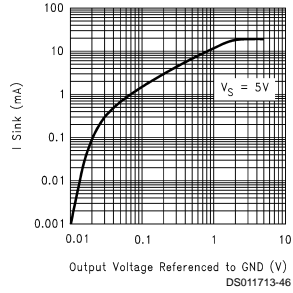


**Sinking Current vs Output Voltage**

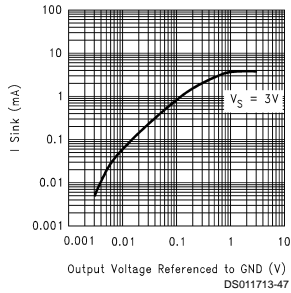


**Typical Performance Characteristics**  $V_S = +15V$ , Single Supply,  $T_A = 25^\circ C$  unless otherwise specified (Continued)

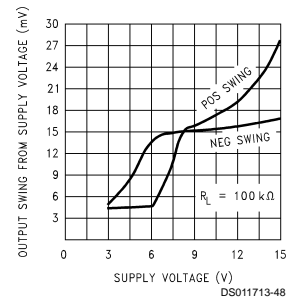
**Sinking Current vs Output Voltage**



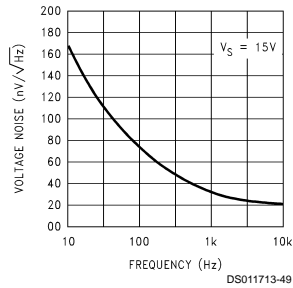
**Sinking Current vs Output Voltage**



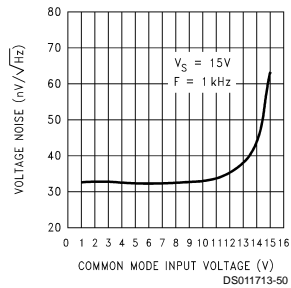
**Output Voltage Swing vs Supply Voltage**



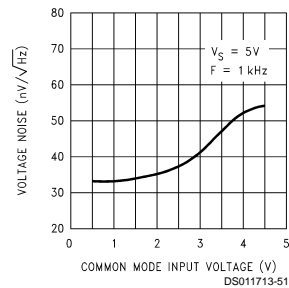
**Input Voltage Noise vs Frequency**



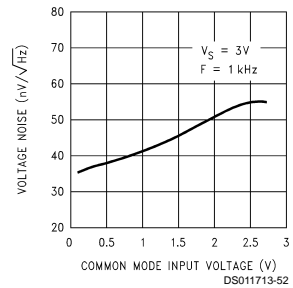
**Input Voltage Noise vs Input Voltage**



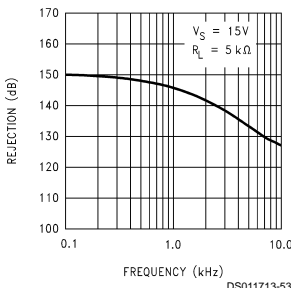
**Input Voltage Noise vs Input Voltage**



**Input Voltage Noise vs Input Voltage**

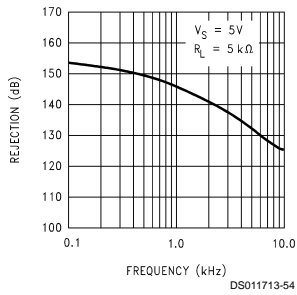


**Crosstalk Rejection vs Frequency**

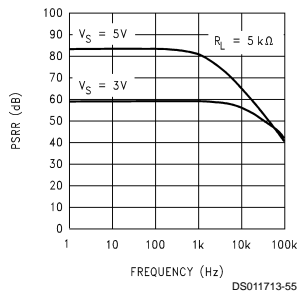


**Typical Performance Characteristics**  $V_S = +15V$ , Single Supply,  $T_A = 25^\circ C$  unless otherwise specified (Continued)

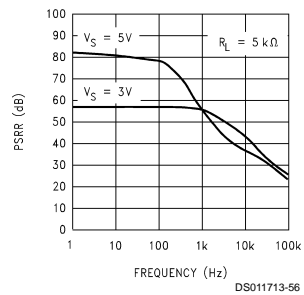
**Crosstalk Rejection vs Frequency**



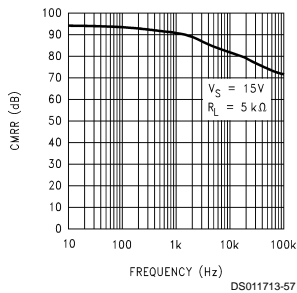
**Positive PSRR vs Frequency**



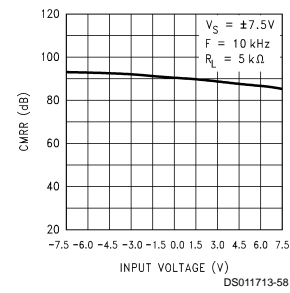
**Negative PSRR vs Frequency**



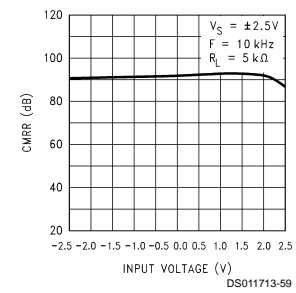
**CMRR vs Frequency**



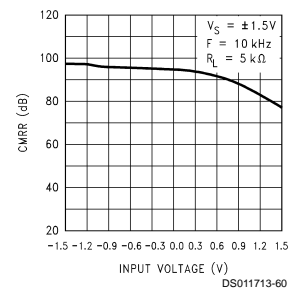
**CMRR vs Input Voltage**



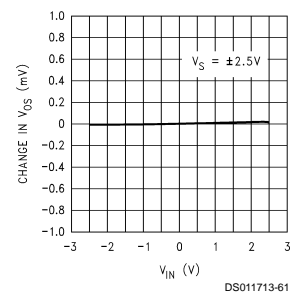
**CMRR vs Input Voltage**



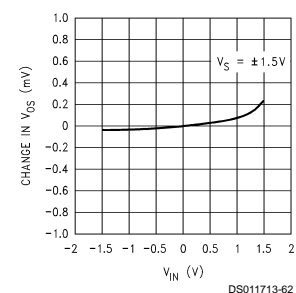
**CMRR vs Input Voltage**



**$\Delta V_{OS}$  vs CMR**



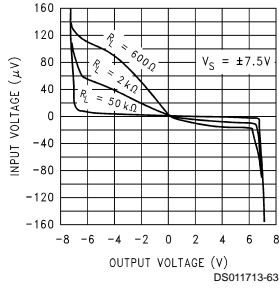
**$\Delta V_{OS}$  vs CMR**



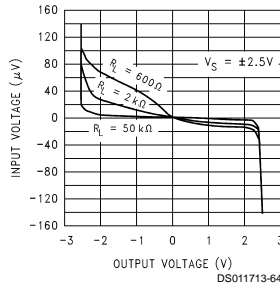


**Typical Performance Characteristics**  $V_S = +15V$ , Single Supply,  $T_A = 25^\circ C$  unless otherwise specified (Continued)

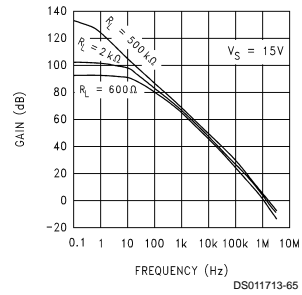
**Input Voltage vs Output Voltage**



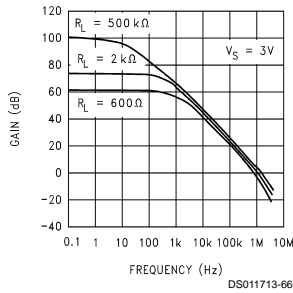
**Input Voltage vs Output Voltage**



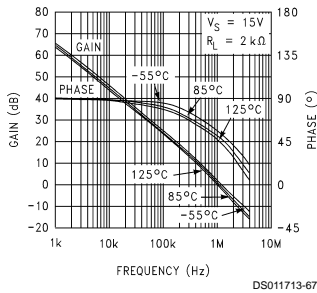
**Open Loop Frequency Response**



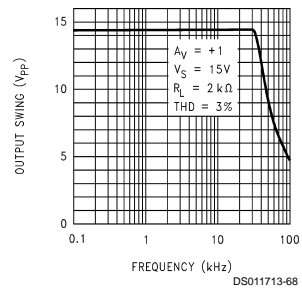
**Open Loop Frequency Response**



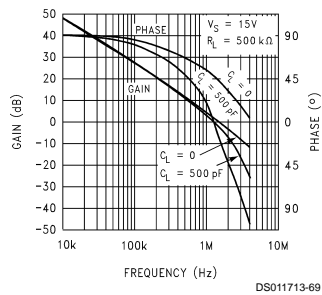
**Open Loop Frequency Response vs Temperature**



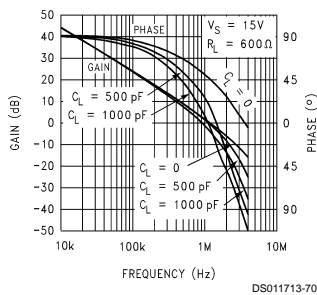
**Maximum Output Swing vs Frequency**



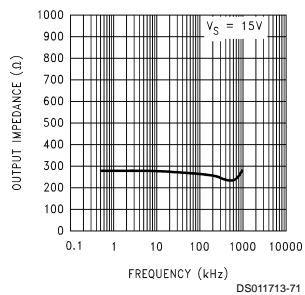
**Gain and Phase vs Capacitive Load**



**Gain and Phase vs Capacitive Load**

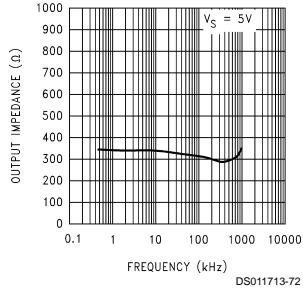


**Open Loop Output Impedance vs Frequency**

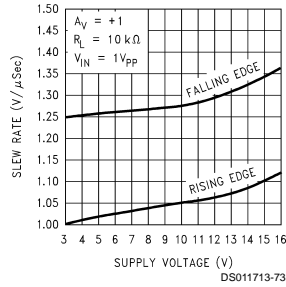


**Typical Performance Characteristics**  $V_S = +15V$ , Single Supply,  $T_A = 25^\circ C$  unless otherwise specified (Continued)

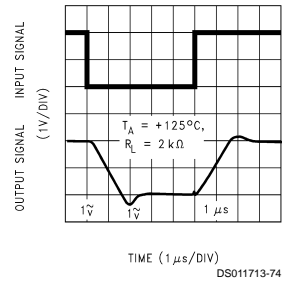
**Open Loop Output Impedance vs Frequency**



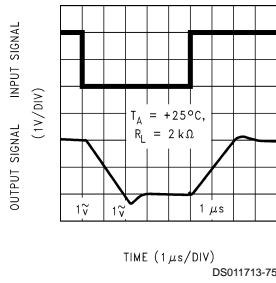
**Slew Rate vs Supply Voltage**



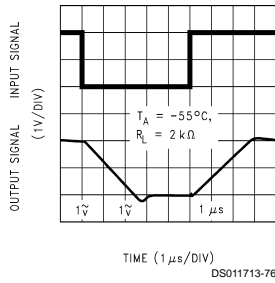
**Non-Inverting Large Signal Pulse Response**



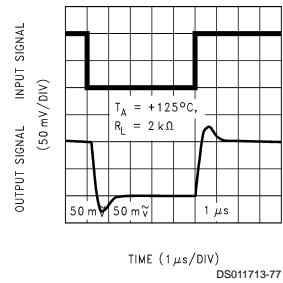
**Non-Inverting Large Signal Pulse Response**



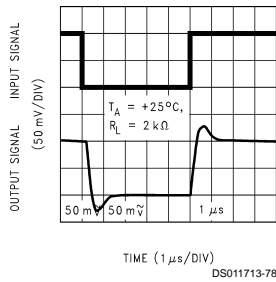
**Non-Inverting Large Signal Pulse Response**



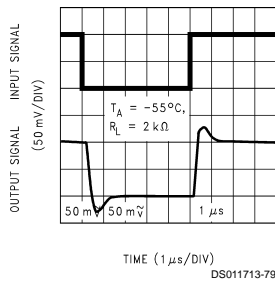
**Non-Inverting Small Signal Pulse Response**



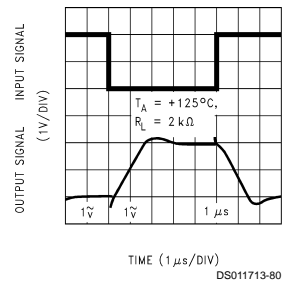
**Non-Inverting Small Signal Pulse Response**



**Non-Inverting Small Signal Pulse Response**

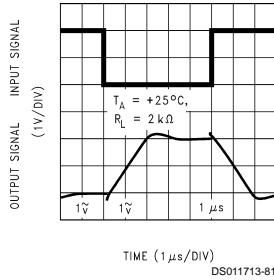


**Inverting Large Signal Pulse Response**

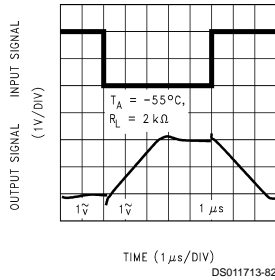


**Typical Performance Characteristics**  $V_S = +15V$ , Single Supply,  $T_A = 25^\circ C$  unless otherwise specified (Continued)

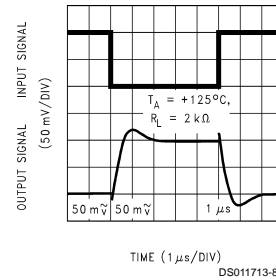
**Inverting Large Signal Pulse Response**



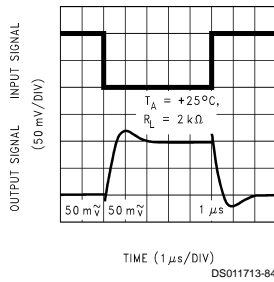
**Inverting Large Signal Pulse Response**



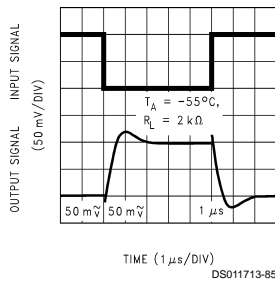
**Inverting Small Signal Pulse Response**



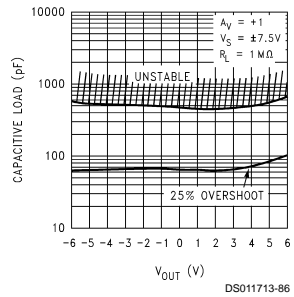
**Inverting Small Signal Pulse Response**



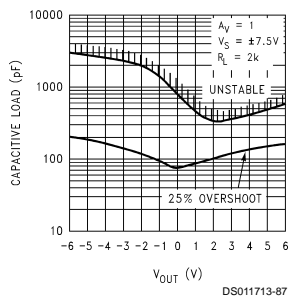
**Inverting Small Signal Pulse Response**



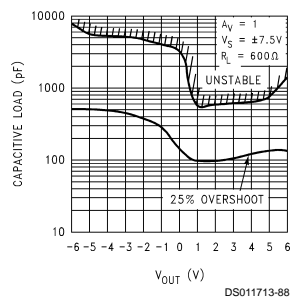
**Stability vs Capacitive Load**



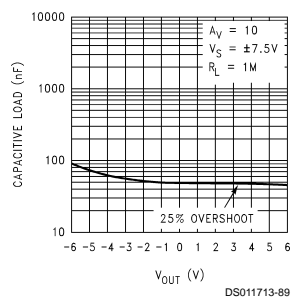
**Stability vs Capacitive Load**



**Stability vs Capacitive Load**

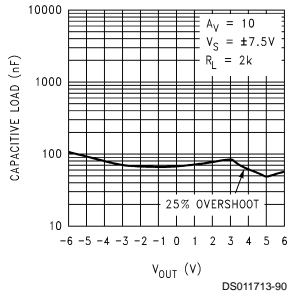


**Stability vs Capacitive Load**

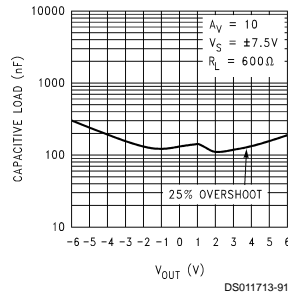


**Typical Performance Characteristics**  $V_S = +15V$ , Single Supply,  $T_A = 25^\circ C$  unless otherwise specified (Continued)

**Stability vs Capacitive Load**



**Stability vs Capacitive Load**



**Application Information**

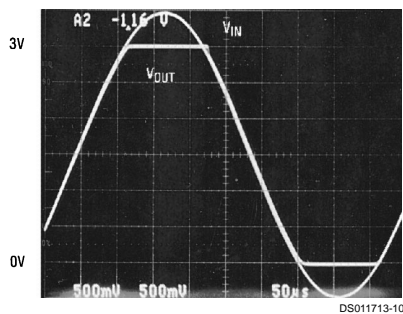
**1.0 Amplifier Topology**

The LMC6482 incorporates specially designed wide-compliance range current mirrors and the body effect to extend input common mode range to each supply rail. Complementary paralleled differential input stages, like the type used in other CMOS and bipolar rail-to-rail input amplifiers, were not used because of their inherent accuracy problems due to CMRR, cross-over distortion, and open-loop gain variation.

The LMC6482's input stage design is complemented by an output stage capable of rail-to-rail output swing even when driving a large load. Rail-to-rail output swing is obtained by taking the output directly from the internal integrator instead of an output buffer stage.

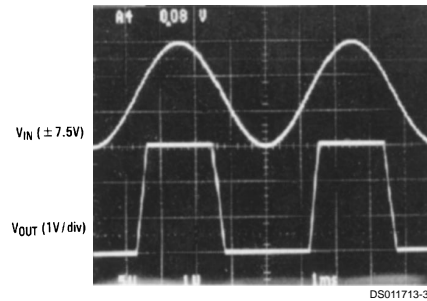
**2.0 Input Common-Mode Voltage Range**

Unlike Bi-FET amplifier designs, the LMC6482 does not exhibit phase inversion when an input voltage exceeds the negative supply voltage. Figure 1 shows an input voltage exceeding both supplies with no resulting phase inversion on the output.



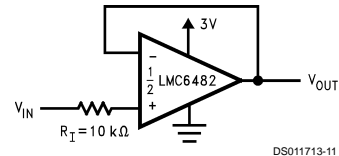
**FIGURE 1. An Input Voltage Signal Exceeds the LMC6482 Power Supply Voltages with No Output Phase Inversion**

The absolute maximum input voltage is 300 mV beyond either supply rail at room temperature. Voltages greatly exceeding this absolute maximum rating, as in Figure 2, can cause excessive current to flow in or out of the input pins possibly affecting reliability.



**FIGURE 2. A ±7.5V Input Signal Greatly Exceeds the 3V Supply in Figure 3 Causing No Phase Inversion Due to  $R_I$**

Applications that exceed this rating must externally limit the maximum input current to  $\pm 5$  mA with an input resistor ( $R_I$ ) as shown in Figure 3.



**FIGURE 3.  $R_I$  Input Current Protection for Voltages Exceeding the Supply Voltages**

**3.0 Rail-To-Rail Output**

The approximated output resistance of the LMC6482 is 180Ω sourcing and 130Ω sinking at  $V_S = 3V$  and 110Ω sourcing and 80Ω sinking at  $V_S = 5V$ . Using the calculated output resistance, maximum output voltage swing can be estimated as a function of load.

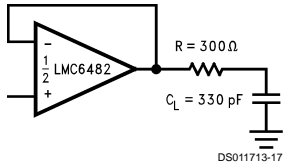
**4.0 Capacitive Load Tolerance**

The LMC6482 can typically directly drive a 100 pF load with  $V_S = 15V$  at unity gain without oscillating. The unity gain follower is the most sensitive configuration. Direct capacitive loading reduces the phase margin of op-amps. The combi-

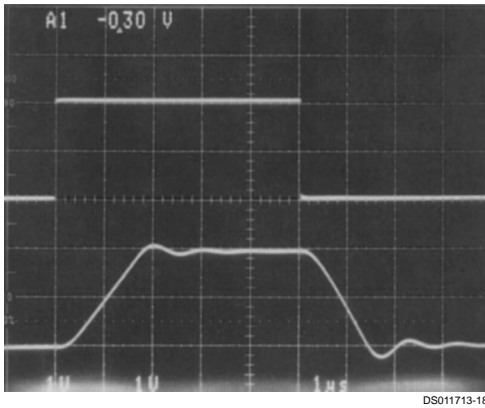
## Application Information (Continued)

nation of the op-amp's output impedance and the capacitive load induces phase lag. This results in either an under-damped pulse response or oscillation.

Capacitive load compensation can be accomplished using resistive isolation as shown in *Figure 4*. This simple technique is useful for isolating the capacitive inputs of multiplexers and A/D converters.

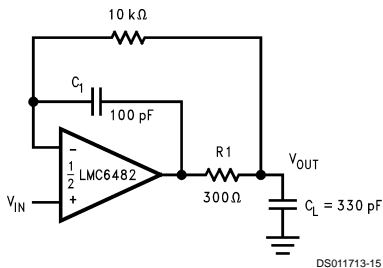


**FIGURE 4. Resistive Isolation of a 330 pF Capacitive Load**



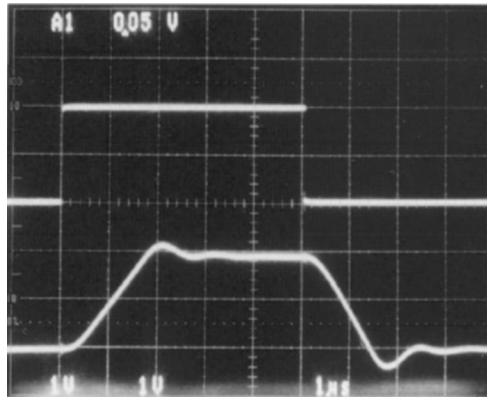
**FIGURE 5. Pulse Response of the LMC6482 Circuit in Figure 4**

Improved frequency response is achieved by indirectly driving capacitive loads, as shown in *Figure 6*.



**FIGURE 6. LMC6482 Noninverting Amplifier, Compensated to Handle a 330 pF Capacitive Load**

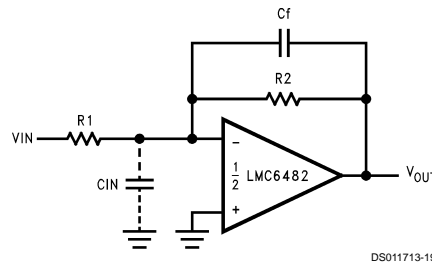
R1 and C1 serve to counteract the loss of phase margin by feeding forward the high frequency component of the output signal back to the amplifiers inverting input, thereby preserving phase margin in the overall feedback loop. The values of R1 and C1 are experimentally determined for the desired pulse response. The resulting pulse response can be seen in *Figure 7*.



**FIGURE 7. Pulse Response of LMC6482 Circuit in Figure 6**

### 5.0 Compensating for Input Capacitance

It is quite common to use large values of feedback resistance with amplifiers that have ultra-low input current, like the LMC6482. Large feedback resistors can react with small values of input capacitance due to transducers, photodiodes, and circuits board parasitics to reduce phase margins.



**FIGURE 8. Canceling the Effect of Input Capacitance**

The effect of input capacitance can be compensated for by adding a feedback capacitor. The feedback capacitor (as in *Figure 8*),  $C_f$ , is first estimated by:

$$\frac{1}{2\pi R_1 C_{IN}} \geq \frac{1}{2\pi R_2 C_f}$$

or

$$R_1 C_{IN} \leq R_2 C_f$$

which typically provides significant overcompensation.

Printed circuit board stray capacitance may be larger or smaller than that of a bread-board, so the actual optimum value for  $C_f$  may be different. The values of  $C_f$  should be checked on the actual circuit. (Refer to the LMC660 quad CMOS amplifier data sheet for a more detailed discussion.)

## Application Information (Continued)

### 6.0 Printed-Circuit-Board Layout for High-Impedance Work

It is generally recognized that any circuit which must operate with less than 1000 pA of leakage current requires special layout of the PC board. When one wishes to take advantage of the ultra-low input current of the LMC6482, typically less than 20 fA, it is essential to have an excellent layout. Fortunately, the techniques of obtaining low leakages are quite simple. First, the user must not ignore the surface leakage of the PC board, even though it may sometimes appear acceptably low, because under conditions of high humidity or dust or contamination, the surface leakage will be appreciable.

To minimize the effect of any surface leakage, lay out a ring of foil completely surrounding the LM6482's inputs and the terminals of capacitors, diodes, conductors, resistors, relay terminals, etc. connected to the op-amp's inputs, as in *Figure 9*. To have a significant effect, guard rings should be placed on both the top and bottom of the PC board. This PC foil must then be connected to a voltage which is at the same voltage as the amplifier inputs, since no leakage current can flow between two points at the same potential. For example, a PC board trace-to-pad resistance of  $10^{12}\Omega$ , which is normally considered a very large resistance, could leak 5 pA if the trace were a 5V bus adjacent to the pad of the input. This would cause a 250 times degradation from the LMC6482's actual performance. However, if a guard ring is held within 5 mV of the inputs, then even a resistance of  $10^{11}\Omega$  would cause only 0.05 pA of leakage current. See *Figure 10* for typical connections of guard rings for standard op-amp configurations.

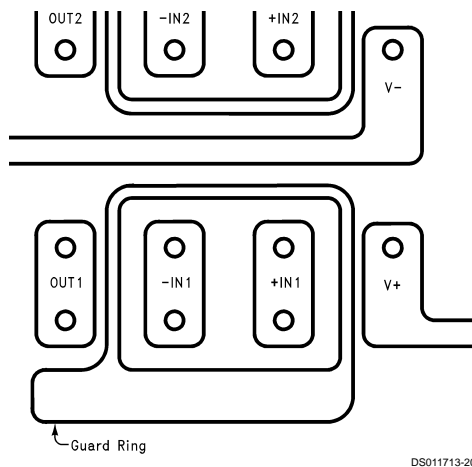
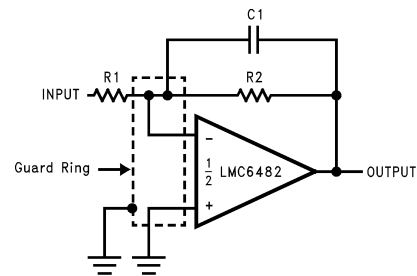
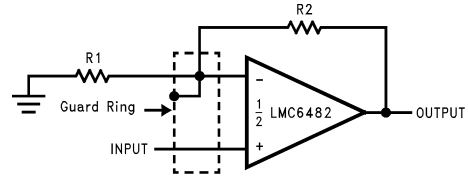


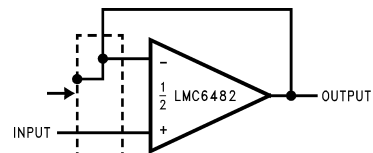
FIGURE 9. Example of Guard Ring in P.C. Board Layout



Inverting Amplifier



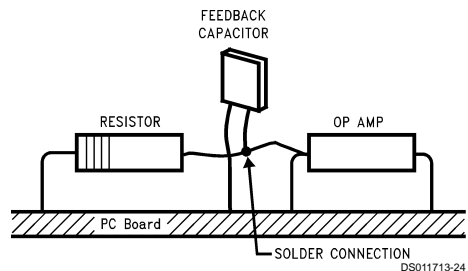
Non-Inverting Amplifier



Follower

FIGURE 10. Typical Connections of Guard Rings

The designer should be aware that when it is inappropriate to lay out a PC board for the sake of just a few circuits, there is another technique which is even better than a guard ring on a PC board: Don't insert the amplifier's input pin into the board at all, but bend it up in the air and use only air as an insulator. Air is an excellent insulator. In this case you may have to forego some of the advantages of PC board construction, but the advantages are sometimes well worth the effort of using point-to-point up-in-the-air wiring. See *Figure 11*.



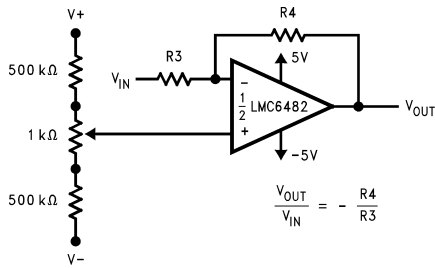
(Input pins are lifted out of PC board and soldered directly to components. All other pins connected to PC board.)

FIGURE 11. Air Wiring

## Application Information (Continued)

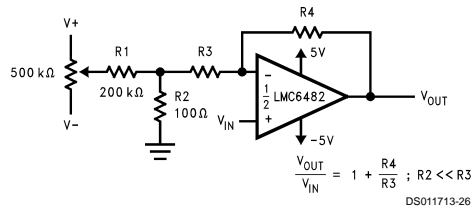
### 7.0 Offset Voltage Adjustment

Offset voltage adjustment circuits are illustrated in *Figure 12* and *Figure 13*. Large value resistances and potentiometers are used to reduce power consumption while providing typically  $\pm 2.5$  mV of adjustment range, referred to the input, for both configurations with  $V_S = \pm 5V$ .



**FIGURE 12. Inverting Configuration Offset Voltage Adjustment**

DS011713-25



**FIGURE 13. Non-Inverting Configuration Offset Voltage Adjustment**

### 8.0 Upgrading Applications

The LMC6484 quads and LMC6482 duals have industry standard pin outs to retrofit existing applications. System performance can be greatly increased by the LMC6482's features. The key benefit of designing in the LMC6482 is increased linear signal range. Most op-amps have limited input common mode ranges. Signals that exceed this range generate a non-linear output response that persists long after the input signal returns to the common mode range.

Linear signal range is vital in applications such as filters where signal peaking can exceed input common mode ranges resulting in output phase inversion or severe distortion.

### 9.0 Data Acquisition Systems

Low power, single supply data acquisition system solutions are provided by buffering the ADC12038 with the LMC6482 (*Figure 14*). Capable of using the full supply range, the LMC6482 does not require input signals to be scaled down to meet limited common mode voltage ranges. The LMC4282 CMRR of 82 dB maintains integral linearity of a 12-bit data acquisition system to  $\pm 0.325$  LSB. Other rail-to-rail input amplifiers with only 50 dB of CMRR will degrade the accuracy of the data acquisition system to only 8 bits.





## Application Information (Continued)

for offset voltage, CMRR and gain. Low cost and low power consumption are the main advantages of this two op-amp circuit.

Higher frequency and larger common-mode range applications are best facilitated by a three op-amp instrumentation amplifier.

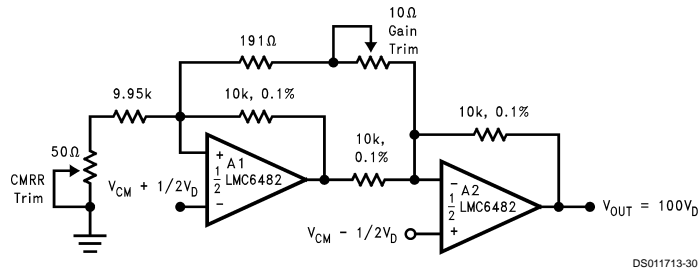


FIGURE 16. Low-Power Two-Op-Amp Instrumentation Amplifier

### 11.0 Spice Macromodel

A spice macromodel is available for the LMC6482. This model includes accurate simulation of:

- Input common-mode voltage range
- Frequency and transient response
- GBW dependence on loading conditions
- Quiescent and dynamic supply current
- Output swing dependence on loading conditions

and many more characteristics as listed on the macromodel disk.

Contact your local National Semiconductor sales office to obtain an operational amplifier spice model library disk.

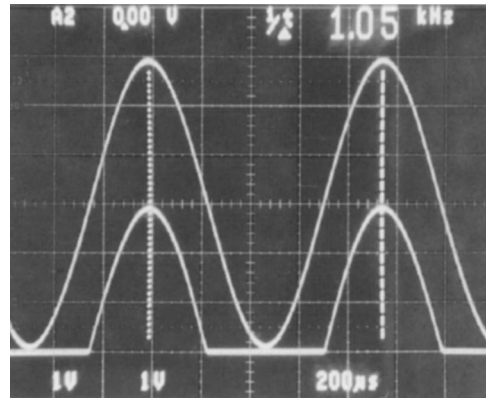


FIGURE 18. Half-Wave Rectifier Waveform

### Typical Single-Supply Applications

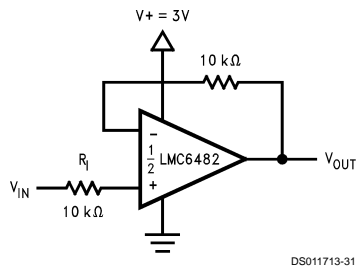


FIGURE 17. Half-Wave Rectifier with Input Current Protection ( $R_1$ )

The circuit in Figure 17 uses a single supply to half wave rectify a sinusoid centered about ground.  $R_1$  limits current into the amplifier caused by the input voltage exceeding the supply voltage. Full wave rectification is provided by the circuit in Figure 19.

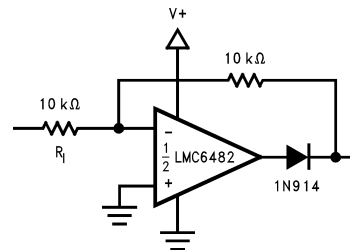


FIGURE 19. Full Wave Rectifier with Input Current Protection ( $R_1$ )

## Typical Single-Supply Applications (Continued)

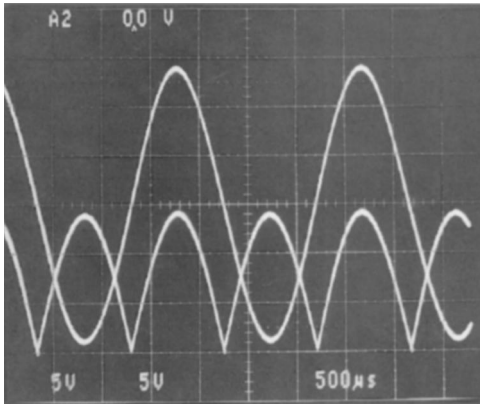


FIGURE 20. Full Wave Rectifier Waveform

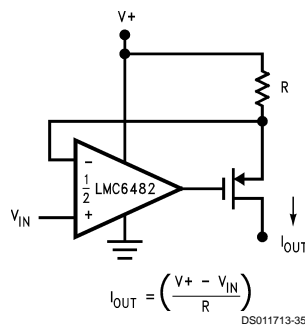


FIGURE 21. Large Compliance Range Current Source

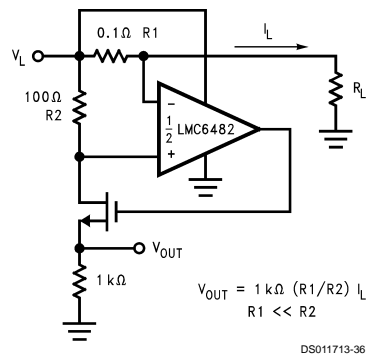
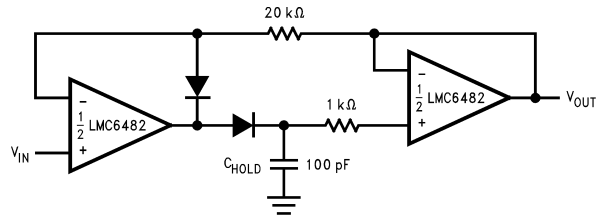


FIGURE 22. Positive Supply Current Sense

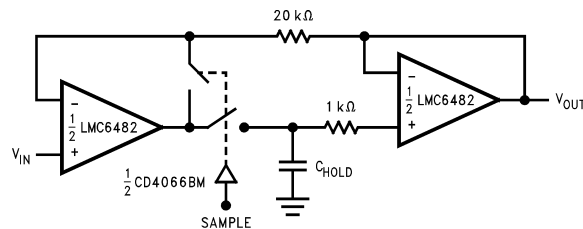
## Typical Single-Supply Applications (Continued)



DS011713-37

**FIGURE 23. Low Voltage Peak Detector with Rail-to-Rail Peak Capture Range**

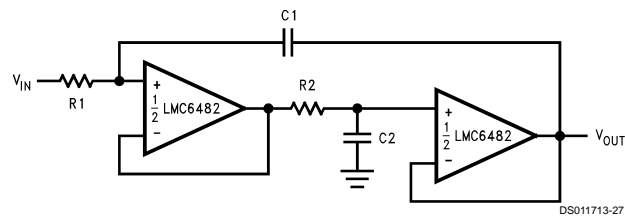
In *Figure 23* dielectric absorption and leakage is minimized by using a polystyrene or polyethylene hold capacitor. The droop rate is primarily determined by the value of  $C_H$  and diode leakage current. The ultra-low input current of the LMC6482 has a negligible effect on droop.



DS011713-38

**FIGURE 24. Rail-to-Rail Sample and Hold**

The LMC6482's high CMRR (82 dB) allows excellent accuracy throughout the circuit's rail-to-rail dynamic capture range.



DS011713-27

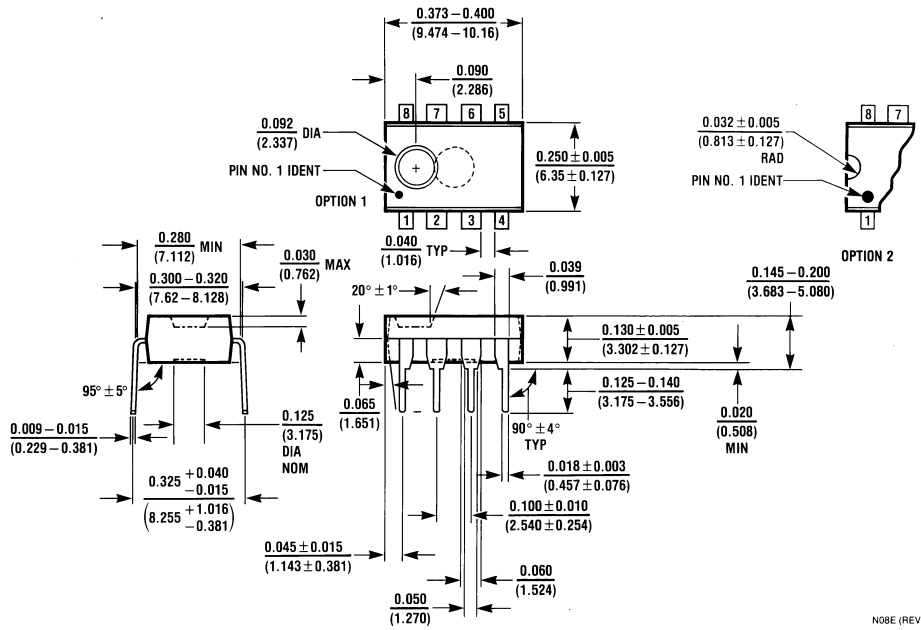
$$R1 = R2, C1 = C2; f = \frac{1}{2\pi R1 C1}; DF = \frac{1}{2} \sqrt{\frac{C2}{C1}} \sqrt{\frac{R2}{R1}}$$

**FIGURE 25. Rail-to-Rail Single Supply Low Pass Filter**

The low pass filter circuit in *Figure 25* can be used as an anti-aliasing filter with the same voltage supply as the A/D converter. Filter designs can also take advantage of the LMC6482 ultra-low input current. The ultra-low input current yields negligible offset error even when large value resistors are used. This in turn allows the use of smaller valued capacitors which take less board space and cost less.



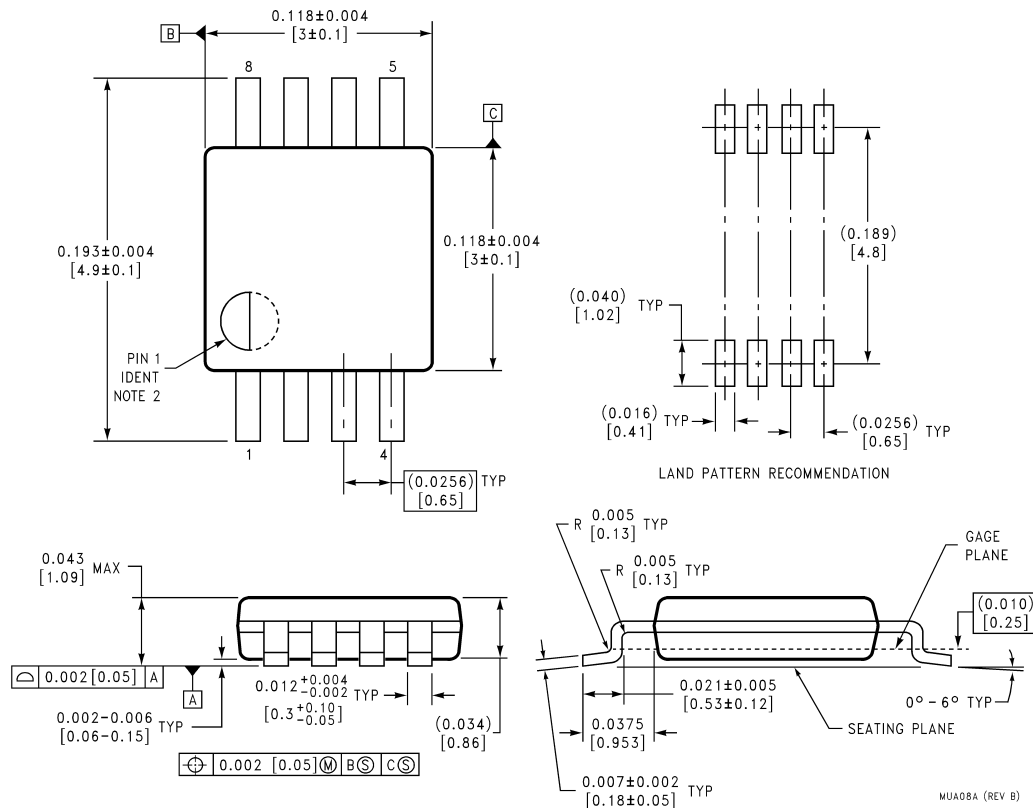
**Physical Dimensions** inches (millimeters) unless otherwise noted (Continued)



**8-Pin Molded Dual-In-Line Package**  
**Order Package Number LMC6482AIN, LMC6482IN or LMC6482MN**  
**NS Package Number N08E**

NO8E (REV F)

**Physical Dimensions** inches (millimeters) unless otherwise noted (Continued)



**8-Lead Mini Small Outline Molded Package, JEDEC**  
**Order Number LMC6482IMM, or LMC6482IMMX**  
**NS Package Number MUA08A**

**LIFE SUPPORT POLICY**

NATIONAL'S PRODUCTS ARE NOT AUTHORIZED FOR USE AS CRITICAL COMPONENTS IN LIFE SUPPORT DEVICES OR SYSTEMS WITHOUT THE EXPRESS WRITTEN APPROVAL OF THE PRESIDENT OF NATIONAL SEMICONDUCTOR CORPORATION. As used herein:

1. Life support devices or systems are devices or systems which, (a) are intended for surgical implant into the body, or (b) support or sustain life, and whose failure to perform when properly used in accordance with instructions for use provided in the labeling, can be reasonably expected to result in a significant injury to the user.
2. A critical component is any component of a life support device or system whose failure to perform can be reasonably expected to cause the failure of the life support device or system, or to affect its safety or effectiveness.

**National Semiconductor Corporation**  
 Americas  
 Tel: 1-800-272-9959  
 Fax: 1-800-737-7018  
 Email: support@nsc.com

**National Semiconductor Europe**  
 Fax: +49 (0) 1 80-530 85 86  
 Email: europe.support@nsc.com  
 Deutsch Tel: +49 (0) 1 80-530 85 85  
 English Tel: +49 (0) 1 80-532 78 32  
 Français Tel: +49 (0) 1 80-532 93 58  
 Italiano Tel: +49 (0) 1 80-534 16 80

**National Semiconductor Asia Pacific Customer Response Group**  
 Tel: 65-2544466  
 Fax: 65-2504466  
 Email: sea.support@nsc.com

**National Semiconductor Japan Ltd.**  
 Tel: 81-3-5639-7560  
 Fax: 81-3-5639-7507

www.national.com