

## CMOS

### Binary Rate Multiplier

High-Voltage Types (20-Volt Rating)

■ CD4089B is a low-power 4-bit digital rate multiplier that provides an output pulse rate that is the clock-input-pulse rate multiplied by 1/16 times the binary input. For example, when the binary input number is 13, there will be 13 output pulses for every 16 input pulses. This device may be used in conjunction with an up/down counter and control logic used to perform arithmetic operations (adds, subtract, divide, raise to a power), solve algebraic and differential equations, generate natural logarithms and trigonometric functions, A/D and D/A conversions, and frequency division.

For words of more than 4 bits, CD4089B devices may be cascaded in two different modes: an Add mode and a Multiply mode (see Figs. 14 and 15). In the Add mode some of the gaps left by the more significant unit at the count of 15 are filled in by the less significant units. For example, when two units are cascaded in the Add mode and programmed to 11 and 13, respectively, the more significant unit will have 11 output pulses for every 16 input pulses and the other unit will have 13 output pulses for every 256 input pulses for a total of

$$\frac{11}{16} + \frac{13}{256} = \frac{189}{256}$$

In the Multiply mode the fraction programmed into the first rate multiplier is multiplied by the fraction programmed into the second multiplier. Thus the output rate will be

$$\frac{11}{16} \times \frac{13}{16} = \frac{143}{256}$$

#### MAXIMUM RATINGS, Absolute-Maximum Values:

DC SUPPLY-VOLTAGE RANGE, (V <sub>DD</sub> )	
Voltages referenced to V <sub>SS</sub> Terminal	..... -0.5V to +20V
INPUT VOLTAGE RANGE, ALL INPUTS	..... -0.5V to V <sub>DD</sub> +0.5V
DQ INPUT CURRENT, ANY ONE INPUT	..... ±10mA
POWER DISSIPATION PER PACKAGE (P <sub>D</sub> ):	
For T <sub>A</sub> = -55°C to +100°C	..... 500mW
For T <sub>A</sub> = +100°C to +125°C	..... Derate Linearly at 12mW/°C to 200mW
DEVICE DISSIPATION PER OUTPUT TRANSISTOR	
FOR T <sub>A</sub> = FULL PACKAGE-TEMPERATURE RANGE (All Package Types)	..... 100mW
OPERATING-TEMPERATURE RANGE (T <sub>A</sub> )	..... -55°C to +125°C
STORAGE TEMPERATURE RANGE (T <sub>stg</sub> )	..... -65°C to +150°C
LEAD TEMPERATURE (DURING SOLDERING):	
At distance 1/16 ± 1/32 inch (1.59 ± 0.79mm) from case for 10s max	..... +265°C

#### Features:

- Cascadable in multiples of 4-bits
- Set to "15" input and "15" detect output
- 100% tested for quiescent current at 20 V
- 5-V, 10-V, and 15-V parametric ratings
- Standardized, symmetrical output characteristics
- Maximum input current of 1 μA at 18 V over full package-temperature range; 100 nA at 18 V and 25°C
- Noise margin (full package-temperature range) =

- 1 V at V<sub>DD</sub> = 5 V
- 2 V at V<sub>DD</sub> = 10 V
- 2.5 V at V<sub>DD</sub> = 15 V

- Meets all requirements of JEDEC Tentative Standard No. 13B, "Standard Specifications for Description of 'B' Series CMOS Devices"

#### Applications:

- Numerical control
- Instrumentation
- Digital filtering
- Frequency synthesis

The CD4089B has an internal synchronous 4-bit counter which, together with one of the four binary input bits, produces pulse trains as shown in Fig. 2.

If more than one binary input bit is high, the resulting pulse train is a combination of the separate pulse trains as shown in Fig. 2.

The CD4089B types are supplied in 16-lead ceramic dual-in-line packages (D and F suffixes), 16-lead dual-in-line plastic packages (E suffix), and in chip form (H suffix).

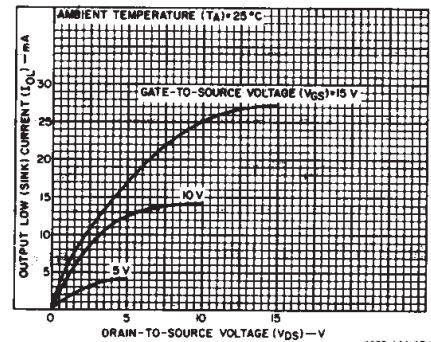
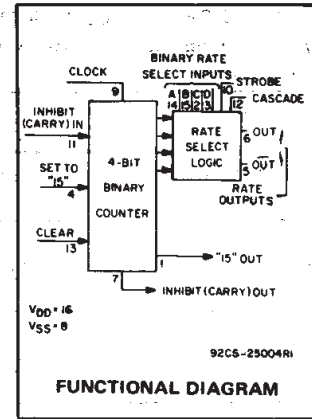

Fig. 1 - Typical output low (sink) current characteristics.

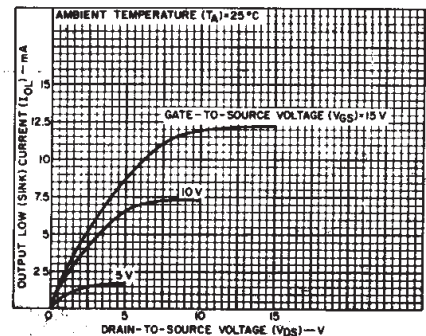

Fig. 2 - Minimum output low (sink) current characteristics.

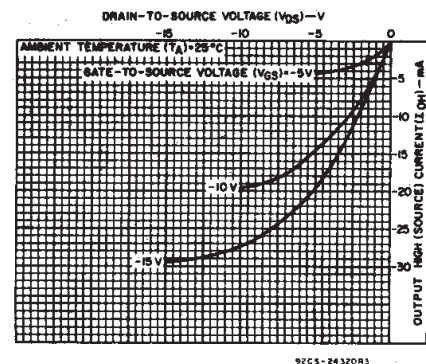

Fig. 3 - Typical output high (source) current characteristics.

3  
COMMERCIAL CMOS  
HIGH VOLTAGE ICs

# CD4089B Types

**RECOMMENDED OPERATING CONDITIONS** at  $T_A = 25^\circ\text{C}$ , Except as Noted. For maximum reliability, nominal operating conditions should be selected so that operation is always within the following ranges:

CHARACTERISTIC	$V_{DD}$ (V)	LIMITS		UNITS
		Min.	Max.	
Supply-Voltage Range (For $T_A$ = Full Package-Temperature Range)		3	18	V
Set or Clear Pulse Width, $t_W$	5 10 15	160 90 60	— — —	ns
Clock Pulse Width, $t_W$	5 10 15	330 170 100	— — —	ns
Clock Frequency, $f_{CL}$	5 10 15	dc	1.2 2.5 3.5	MHz
Clock Rise or Fall Time, $t_{rCL}$ or $t_{fCL}$	5, 10,15	—	15	$\mu\text{s}$
Inhibit In Setup Time, $t_{SU}$	5 10 15	100 40 20	— — —	ns
Inhibit In Removal Time, $t_{REM}$	5 10 15	240 130 110	— — —	ns
Set Removal Time, $t_{REM}$	5 10 15	150 80 50	— — —	ns
Clear Removal Time, $t_{REM}$	5 10 15	60 40 30	— — —	ns

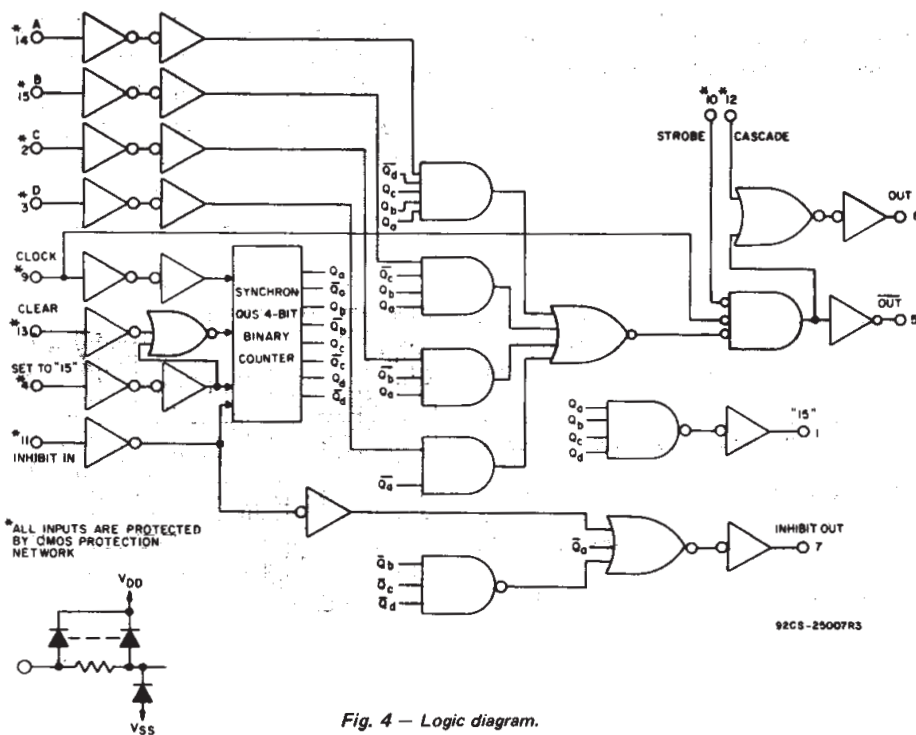

Fig. 4 — Logic diagram.

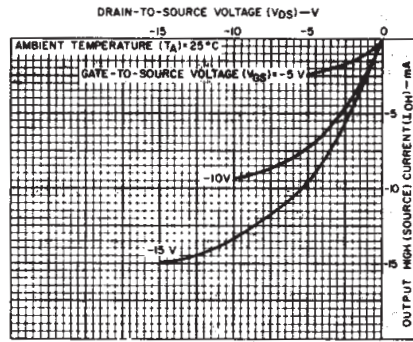

Fig. 5 — Minimum output high (source) current characteristics.

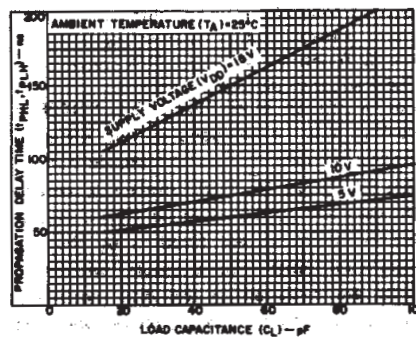

Fig. 6 — Typical propagation delay time as a function of load capacitance (Clock or Strobe to Out).

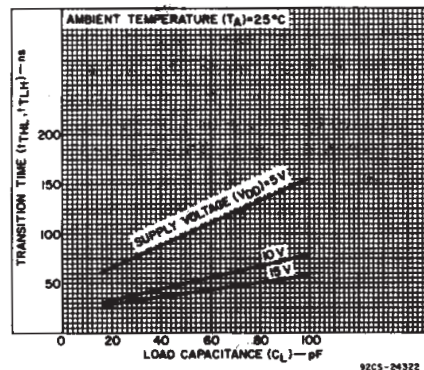

Fig. 7 — Typical transition time as a function of load capacitance.

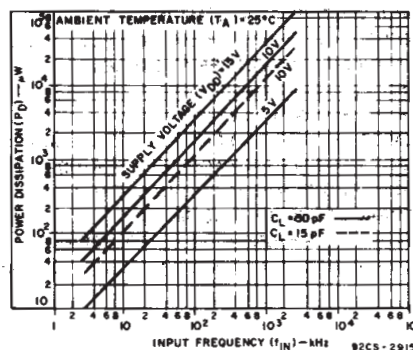

Fig. 8 — Typical dynamic power dissipation as a function of input frequency.

# CD4089B Types

DYNAMIC ELECTRICAL CHARACTERISTICS at  $T_A = 25^\circ\text{C}$ :  
 Input  $t_r, t_f = 20 \text{ ns}$ ,  $C_L = 50 \text{ pF}$ ,  $R_L = 200 \text{ k}\Omega$

CHARACTERISTIC	TEST CONDITIONS	LIMITS			UNITS	
		VDD V	Min.	Typ.		Max.
Propagation Delay Time, $t_{PHL}, t_{PLH}$ Clock to $\overline{\text{Out}}$		5	—	110	220	ns
		10	—	55	110	
		15	—	45	90	
Clock or Strobe to Out		5	—	150	300	ns
		10	—	75	150	
		15	—	60	120	
Clock to Inhibit Out High Level to Low Level		5	—	360	720	ns
		10	—	160	320	
		15	—	110	220	
Low Level to High Level		5	—	250	500	ns
		10	—	100	200	
		15	—	75	150	
Clear to Out		5	—	380	760	ns
		10	—	175	350	
		15	—	130	260	
Clock to "9" or "15" Out		5	—	300	600	ns
		10	—	125	250	
		15	—	90	180	
Cascade to Out		5	—	90	180	ns
		10	—	45	90	
		15	—	35	70	
Inhibit In to Inhibit Out		5	—	160	320	ns
		10	—	75	150	
		15	—	55	110	
Set to Out		5	—	330	660	ns
		10	—	150	300	
		15	—	110	220	
Transition Time, $t_{THL}, t_{TLH}$		5	—	100	200	ns
		10	—	50	100	
		15	—	40	80	
Maximum Clock Frequency, $f_{CL}$		5	1.2	2.4	—	MHz
		10	2.5	5	—	
		15	3.5	7	—	
Minimum Clock Pulse Width, $t_W$		5	—	165	330	ns
		10	—	85	170	
		15	—	50	100	
Clock Rise or Fall Time, $t_{rCL}, t_{fCL}$		5	—	—	15	$\mu\text{s}$
		10	—	—	15	
		15	—	—	15	
Minimum Set or Clear Pulse Width, $t_W$		5	—	80	160	ns
		10	—	45	90	
		15	—	30	60	
Minimum Inhibit-In Setup Time, $t_{SU}$		5	—	50	100	ns
		10	—	20	40	
		15	—	10	20	
Minimum Inhibit In Removal Time, $t_{REM}$		5	—	120	240	ns
		10	—	65	130	
		15	—	55	110	

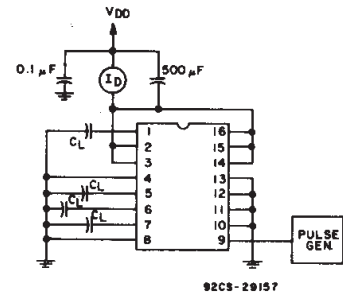

Fig. 9 — Dynamic power dissipation test circuit.

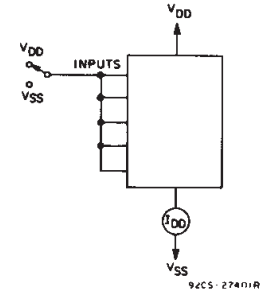

Fig. 10 — Quiescent device current test circuit.

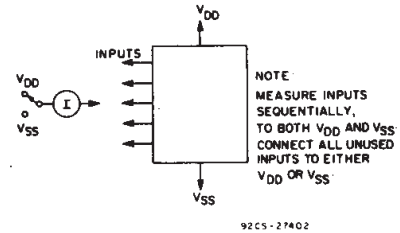

Fig. 11 — Input-current test circuit.

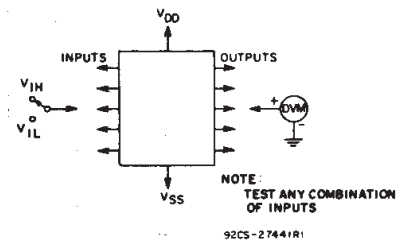
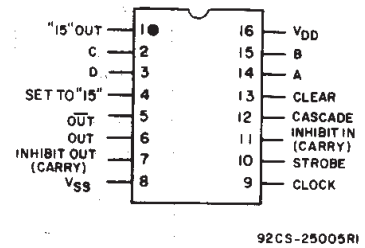

Fig. 12 — Input-voltage test circuit.



TOP VIEW  
TERMINAL ASSIGNMENT

3  
COMMERCIAL CMOS  
HIGH VOLTAGE ICs

## CD4089B Types

**DYNAMIC ELECTRICAL CHARACTERISTICS at  $T_A = 25^\circ\text{C}$  (cont'd)**  
 Input  $t_r, t_f = 20 \text{ ns}$ ,  $C_L = 50 \text{ pF}$ ,  $R_L = 200 \text{ k}\Omega$

CHARACTERISTIC	TEST CONDITIONS	LIMITS				UNITS
		$V_{DD}$ V				
			Min.	Typ.	Max.	
Minimum Set Removal Time, $t_{REM}$		5	—	75	150	ns
		10	—	40	80	
		15	—	25	50	
Minimum Clear Removal Time, $t_{REM}$		5	—	30	60	ns
		10	—	20	40	
		15	—	15	30	
Input Capacitance, $C_{IN}$	Any Input	—	—	5	7.5	pF

### STATIC ELECTRICAL CHARACTERISTICS

CHARACTERISTIC	CONDITIONS			LIMITS AT INDICATED TEMPERATURES ( $^\circ\text{C}$ )							UNITS
							+25				
	$V_O$ (V)	$V_{IN}$ (V)	$V_{DD}$ (V)	-55	-40	+85	+125	Min.	Typ.	Max.	
Quiescent Device Current, $I_{DD}$ Max.	—	0,5	5	5	5	150	150	—	0.04	5	$\mu\text{A}$
	—	0,10	10	10	10	300	300	—	0.04	10	
	—	0,15	15	20	20	600	600	—	0.04	20	
	—	0,20	20	100	100	3000	3000	—	0.08	100	
Output Low (Sink) Current $I_{OL}$ Min.	0.4	0,5	5	0.64	0.61	0.42	0.36	0.51	1	—	$\text{mA}$
	0.5	0,10	10	1.6	1.5	1.1	0.9	1.3	2.6	—	
	1.5	0,15	15	4.2	4	2.8	2.4	3.4	6.8	—	
Output High (Source) Current, $I_{OH}$ Min.	4.6	0,5	5	-0.64	-0.61	-0.42	-0.36	-0.51	-1	—	$\text{mA}$
	2.5	0,5	5	-2	-1.8	-1.3	-1.15	-1.6	-3.2	—	
	9.5	0,10	10	-1.6	-1.5	-1.1	-0.9	-1.3	-2.6	—	
	13.5	0,15	15	-4.2	-4	-2.8	-2.4	-3.4	-6.8	—	
Output Voltage: Low-Level, $V_{OL}$ Max.	—	0,5	5	0.05				—	0	0.05	V
	—	0,10	10	0.05				—	0	0.05	
	—	0,15	15	0.05				—	0	0.05	
Output Voltage: High-Level, $V_{OH}$ Min.	—	0,5	5	4.95				4.95	5	—	V
	—	0,10	10	9.95				9.95	10	—	
	—	0,15	15	14.95				14.95	15	—	
Input Low Voltage $V_{IL}$ Max.	0.5,4.5	—	5	1.5				—	—	1.5	V
	1.9	—	10	3				—	—	3	
	1.5,13.5	—	15	4				—	—	4	
Input High Voltage, $V_{IH}$ Min.	0.5,4.5	—	5	3.5				3.5	—	—	V
	1.9	—	10	7				7	—	—	
	1.5,13.5	—	15	11				11	—	—	
Input Current $I_{IN}$ Max.	—	0,18	18	$\pm 0.1$	$\pm 0.1$	$\pm 1$	$\pm 1$	—	$\pm 10^{-5}$	$\pm 0.1$	$\mu\text{A}$



# CD4089B Types

TRUTH TABLE

INPUTS										OUTPUTS			
Number of Pulses or Input Logic Level (0 = Low; 1 = High; X = Don't Care)										Number of Pulses or Output Logic Level (L = Low; H = High)			
D	C	B	A	CLK	INH IN	STR	CAS	CLR	SET	OUT	OUT	INH OUT	"15" OUT
0	0	0	0	16	0	0	0	0	0	L	H	1	1
0	0	0	1	16	0	0	0	0	0	1	1	1	1
0	0	1	0	16	0	0	0	0	0	2	2	1	1
0	0	1	1	16	0	0	0	0	0	3	3	1	1
0	1	0	0	16	0	0	0	0	0	4	4	1	1
0	1	0	1	16	0	0	0	0	0	5	5	1	1
0	1	1	0	16	0	0	0	0	0	6	6	1	1
0	1	1	1	16	0	0	0	0	0	7	7	1	1
1	0	0	0	16	0	0	0	0	0	8	8	1	1
1	0	0	1	16	0	0	0	0	0	9	9	1	1
1	0	1	0	16	0	0	0	0	0	10	10	1	1
1	0	1	1	16	0	0	0	0	0	11	11	1	1
1	1	0	0	16	0	0	0	0	0	12	12	1	1
1	1	0	1	16	0	0	0	0	0	13	13	1	1
1	1	1	0	16	0	0	0	0	0	14	14	1	1
1	1	1	1	16	0	0	0	0	0	15	15	1	1
X	X	X	X	16	1	0	0	0	0	†	†	H	†
X	X	X	X	16	0	1	0	0	0	L	H	1	1
X	X	X	X	16	0	0	1	0	0	H	*	1	1
1	X	X	X	16	0	0	0	1	0	16	16	H	L
0	X	X	X	16	0	0	0	1	0	L	H	H	L
X	X	X	X	16	0	0	0	X	1	L	H	L	H

\* Output same as the first 16 lines of this truth table (depending on values of A, B, C, D).

† Depends on internal state of counter.

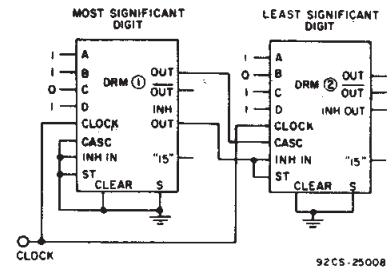

Fig. 13 - Two CD4089B's cascaded in the "Add" mode with a preset number

$$\text{of } 189 \left( \frac{11}{16} + \frac{13}{256} = \frac{189}{256} \right)$$

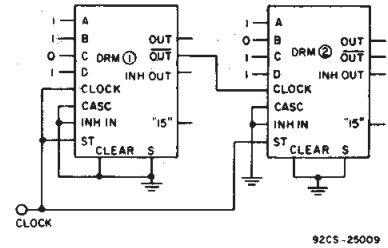
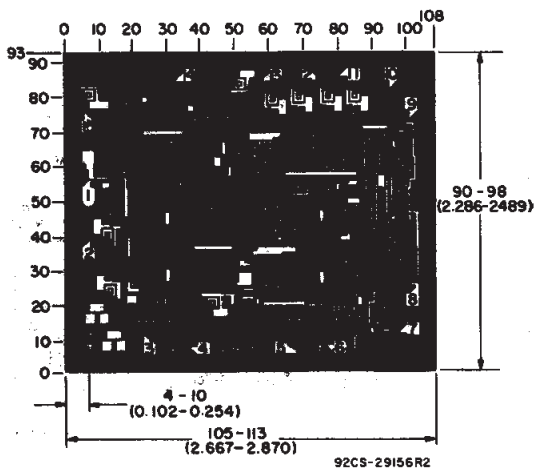

Fig. 14 - Two CD4089B's cascaded in the "Multiply" mode with a preset number

$$\text{of } 143 \left( \frac{11}{16} \times \frac{13}{256} = \frac{143}{256} \right)$$

3  
COMMERCIAL CMOS  
HIGH VOLTAGE ICs



Dimensions and Pad Layout for CD4089BH

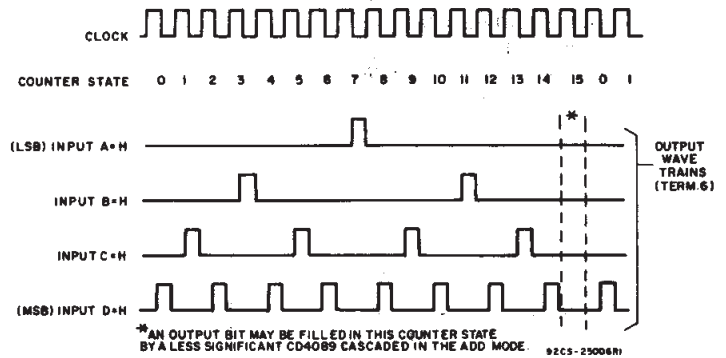

Fig. 15 - Timing diagram.

Dimensions in parentheses are in millimeters and are derived from the basic inch dimensions as indicated. Grid graduations are in mils ( $10^{-3}$  inch).

## IMPORTANT NOTICE

Texas Instruments and its subsidiaries (TI) reserve the right to make changes to their products or to discontinue any product or service without notice, and advise customers to obtain the latest version of relevant information to verify, before placing orders, that information being relied on is current and complete. All products are sold subject to the terms and conditions of sale supplied at the time of order acknowledgement, including those pertaining to warranty, patent infringement, and limitation of liability.

TI warrants performance of its semiconductor products to the specifications applicable at the time of sale in accordance with TI's standard warranty. Testing and other quality control techniques are utilized to the extent TI deems necessary to support this warranty. Specific testing of all parameters of each device is not necessarily performed, except those mandated by government requirements.

CERTAIN APPLICATIONS USING SEMICONDUCTOR PRODUCTS MAY INVOLVE POTENTIAL RISKS OF DEATH, PERSONAL INJURY, OR SEVERE PROPERTY OR ENVIRONMENTAL DAMAGE ("CRITICAL APPLICATIONS"). TI SEMICONDUCTOR PRODUCTS ARE NOT DESIGNED, AUTHORIZED, OR WARRANTED TO BE SUITABLE FOR USE IN LIFE-SUPPORT DEVICES OR SYSTEMS OR OTHER CRITICAL APPLICATIONS. INCLUSION OF TI PRODUCTS IN SUCH APPLICATIONS IS UNDERSTOOD TO BE FULLY AT THE CUSTOMER'S RISK.

In order to minimize risks associated with the customer's applications, adequate design and operating safeguards must be provided by the customer to minimize inherent or procedural hazards.

TI assumes no liability for applications assistance or customer product design. TI does not warrant or represent that any license, either express or implied, is granted under any patent right, copyright, mask work right, or other intellectual property right of TI covering or relating to any combination, machine, or process in which such semiconductor products or services might be or are used. TI's publication of information regarding any third party's products or services does not constitute TI's approval, warranty or endorsement thereof.